



User Guide

AC1200 Wireless Dual Band Gigabit Router
Archer C5

Contents

About This Guide	1
Chapter 1. Get to Know Your Router	2
1. 1. Product Overview	3
1. 2. Appearance	3
1. 2. 1. Top Panel	3
1. 2. 2. Back Panel	5
Chapter 2. Connect the Hardware	6
2. 1. Position Your Router	7
2. 2. Connect Your Router	7
Chapter 3. Log In to Your Router	10
Chapter 4. Set Up Internet Connection	12
4. 1. Use Quick Setup Wizard	13
4. 2. Manually Set Up Your Internet Connection	13
4. 3. Set Up an IPv6 Internet Connection	15
4. 4. More Operation Modes	16
4. 4. 1. Configure the Router in Access Point Mode	16
4. 4. 2. Configure the Router in Range Extender Mode	17
Chapter 5. USB Settings	21
5. 1. Access the USB Storage Device	22
5. 1. 1. Access the USB Device Locally	22
5. 1. 2. Access the USB Device Remotely	23
5. 1. 3. View USB Storage Device	25
5. 1. 4. Customize the Access Settings	26
5. 2. Media Sharing	29
5. 3. 3G/4G Settings	30
Chapter 6. Parental Controls	32
Chapter 7. Bandwidth Control	36
7. 1. Configure the Bandwidth Control	37
7. 2. Controlling Rules	37

Chapter 8. Network Security	39
8.1. Firewall & DoS Protection	40
8.2. Service Filtering	41
8.3. Access Control	42
8.4. IP & MAC Binding	44
Chapter 9. NAT Forwarding.....	46
9.1. Translate Address and Port by ALG.....	47
9.2. Share Local Resources over the Internet by Virtual Server.....	48
9.3. Open Ports Dynamically by Port Triggering.....	49
9.4. Make Applications Free from Port Restriction by DMZ	50
9.5. Make Xbox Online Games Run Smoothly by UPnP	51
Chapter 10.VPN Server	53
10.1. Use OpenVPN to Access Your Home Network.....	54
10.2. Use PPTP VPN to Access Your Home Network	55
Chapter 11.Customize Your Network Settings.....	60
11.1. Configure LAN Settings.....	61
11.1.1. Change the LAN IP Address	61
11.1.2. Use the Router as a DHCP Server.....	62
11.1.3. Reserve LAN IP Addresses	63
11.2. Configure IPv6 LAN Settings.....	63
11.2.1. Configure the RADVD Address Type.....	63
11.2.2. Configure the DHCPv6 Server Address Type	64
11.3. Set Up a Dynamic DNS Service Account	65
11.4. Create Interface Groups	66
11.5. Create Static Routes.....	67
11.6. Set Up the IPv6 Tunnel.....	70
11.6.1. Use the Public IPv6 Tunnel Service-6to4.....	70
11.6.2. Specify the 6rd Tunnel with Parameters Provided by Your ISP	71
11.7. Specify Wireless Settings.....	72
11.7.1. Change Basic Wireless Settings	72
11.7.2. Advanced Wireless Settings.....	74
11.7.3. View Wireless Information	76
11.8. Schedule Your Wireless Function	77
11.9. Use WPS for Wireless Connection	78

Chapter 12. Manage Your Router	81
12. 1. Set System Time	82
12. 2. Test Internet Connectivity	83
12. 3. Update the Firmware.....	84
12. 4. Back Up and Restore Configuration Settings	85
12. 5. Reboot the Router	86
12. 6. Administration Management.....	87
12. 6. 1. Change the Login Password.....	87
12. 6. 2. Local Management.....	87
12. 6. 3. Remote Management	88
12. 6. 4. HTTP Referer Head Check.....	89
12. 6. 5. ICMP Ping	90
12. 7. System Log.....	90
12. 8. CWMP Settings.....	92
12. 9. SNMP Settings	93
12. 10. Monitor the Internet Traffic Statistics.....	94
FAQ	96





About This Guide

This guide is a complement to Quick Installation Guide. The Quick Installation Guide provides instructions for quick internet setup, while this guide contains details of each function and demonstrates how to configure them.

Please note that features of your router may vary slightly depending on the model and software version you have, and on your location, language and internet service provider. All images, parameters and descriptions documented in this guide are used for demonstration only.

Conventions

In this guide the following conventions are used:

Convention	Description
<u>Underlined</u>	Hyperlinks are in teal and underlined. You can click to redirect to a website or a specific section.
Teal	Key information appears in teal, including management page text such as menus, items, buttons and so on.
>	The menu structures to show the path to load the corresponding page. For example, Advanced > Wireless > Wireless Settings means the Wireless Settings function page is under the Wireless menu that is located in the Advanced tab.
Note:	Ignoring this type of note might result in a malfunction or damage to the device.
Tips:	Indicates important information that helps you make better use of your device.
Symbols on the web page	<ul style="list-style-type: none">•  click to edit the corresponding entry.•  click to delete the corresponding entry.•  click to enable or disable the corresponding entry.•  click to view more information about items on the page.

More Info

The latest firmware is available from the [Download Center](http://www.tp-link.com/support) at www.tp-link.com/support.

The Quick Installation Guide can be found where you find this guide or inside the package of the router.

Specifications can be found on the product page at <http://www.tp-link.com>.

A Technical Support Forum is provided for you to discuss our products at <http://forum.tp-link.com>.

Our Technical Support contact information can be found at the [Contact Technical Support](http://www.tp-link.com/support) page at www.tp-link.com/support.

Chapter 1

Get to Know Your Router

This chapter introduces what the router can do and shows its appearance.

This chapter contains the following sections:

- [Product Overview](#)
- [Appearance](#)

1.1. Product Overview

The TP-Link router is designed to fully meet the need of Small Office/Home Office (SOHO) networks and users demanding higher networking performance. The powerful antennas ensure continuous Wi-Fi signal to all your devices while boosting widespread coverage throughout your home, and the built-in Ethernet ports supply high-speed connection to your wired devices.

Moreover, it is simple and convenient to set up and use the TP-Link router due to its intuitive web interface.







1.2. Appearance

1.2.1. Top Panel



The router's LEDs are located on the top panel. You can check the router's working status by following the LED Explanation table.

LED Explanation

Name	Status	Indication
 (Power)	On	The system has started up successfully.
	Flashing	The system is starting up or the router is updating the firmware. Do not disconnect or power off the router.
	Off	Power is off.
 2.4GHz	On	The 2.4GHz wireless band is enabled.
	Off	The 2.4GHz wireless band is disabled.
 5GHz	On	The 5GHz wireless band is enabled.
	Off	The 5GHz wireless band is disabled.
 Internet	Green On	Internet service is available.
	Orange On	The router's WAN port is connected, but the internet service is unavailable.
	Off	The router's WAN port is not connected.
 (LAN)	On	At least one of router's LAN ports is connected.
	Off	No LAN port is connected.
 USB	On	The inserted USB device is ready to use.
	Flashing	A USB device is being identified.
	Off	No device is plugged into the USB port.
 (WPS)	On/Off	Turns on when a WPS connection is established, and turns off about 5 minutes later.
	Flashing	A wireless device is trying to connect to the network via WPS. This process may take up to 2 minutes.

1.2.2. Back Panel



The router's back panel contains the connection ports, buttons and antennas. Refer to the following for detailed instructions.

Item	Description
WPS/Wi-Fi Button	Press this button to establish a WPS connection.
	Press and hold this button for at least 5 seconds to turn on or off the wireless function of your router.
RESET Button	Press and hold this button for at least 5 seconds to reset the router to its factory default settings.
LAN Ports (4/3/2/1)	For connecting your PCs or other Ethernet network devices to the router.
WAN Port	For connecting the router to a DSL/Cable modem, or an Ethernet port.
USB Port	For connecting to a USB device.
ON/OFF Button	Press this button to power on or off the router.
Power Port	For connecting the router to a power socket via the provided power adapter.
Antennas	Used for wireless operation and data transmitting. Upright them for the best Wi-Fi performance.

Chapter 2

Connect the Hardware

This chapter contains the following sections:

- [Position Your Router](#)
- [Connect Your Router](#)

2.1. Position Your Router

- The product should not be located in a place where it will be exposed to moisture or excessive heat.
- Place the router in a location where it can be connected to multiple devices as well as to a power source.
- Make sure the cables and power cord are safely placed out of the way so they do not create a tripping hazard.
- The router can be placed on a shelf or desktop.
- Keep the router away from strong devices with strong electromagnetic interference, such as Bluetooth devices, cordless phones and microwaves.

2.2. Connect Your Router

Follow the steps below to connect your router.

If your internet connection is through an Ethernet cable from the wall instead of through a DSL / Cable / Satellite modem, connect the Ethernet cable directly to the router's WAN port as step 2, and then follow step 4 and 5 to complete the hardware connection.

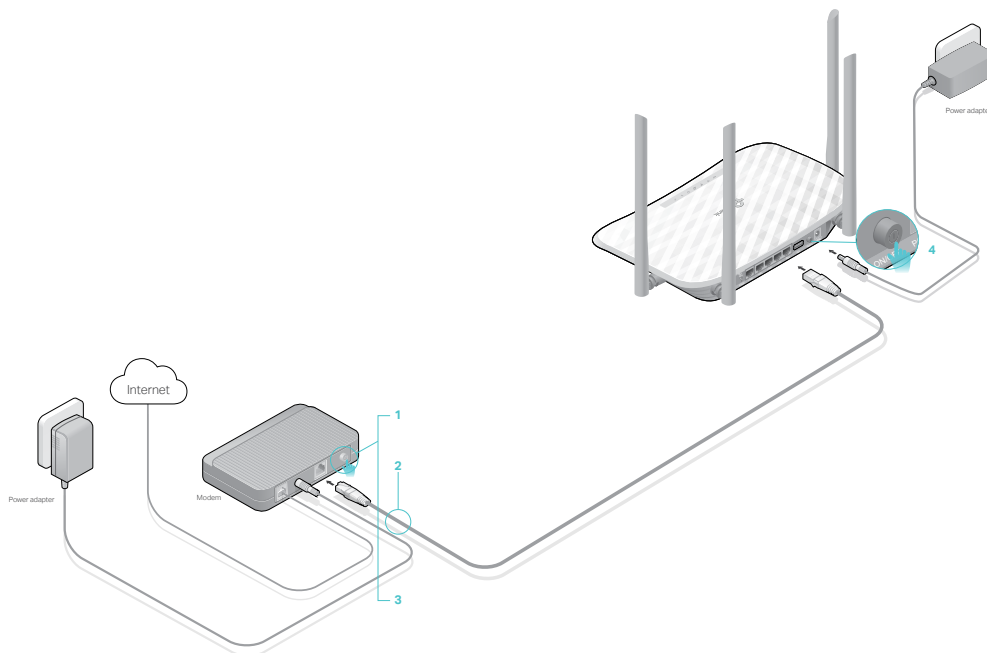

1. Turn off the modem, and remove the backup battery if it has one.
2. Connect the modem to the router's WAN port with an Ethernet cable.
3. Turn on the modem, and then wait about **2 minutes** for it to restart.
4. Connect the power adapter to the router.
5. Verify that the following LEDs are solid on before continuing with the configuration.



6. Connect your computer to the router.

- **Method 1: Wired**

Turn off the Wi-Fi on your computer and connect the devices as shown below.

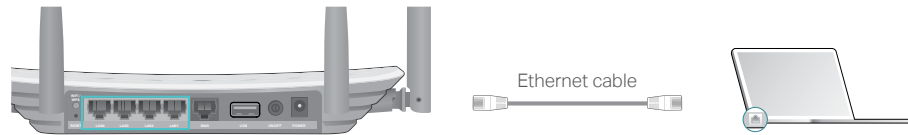

- **Method 2: Wireless**

- 1) Find the SSID (Network Name) and Wireless Password printed on the label at the bottom of the router.
- 2) Click the network icon of your computer or go to Wi-Fi Settings of your smart device, and then select the SSID to join the network.

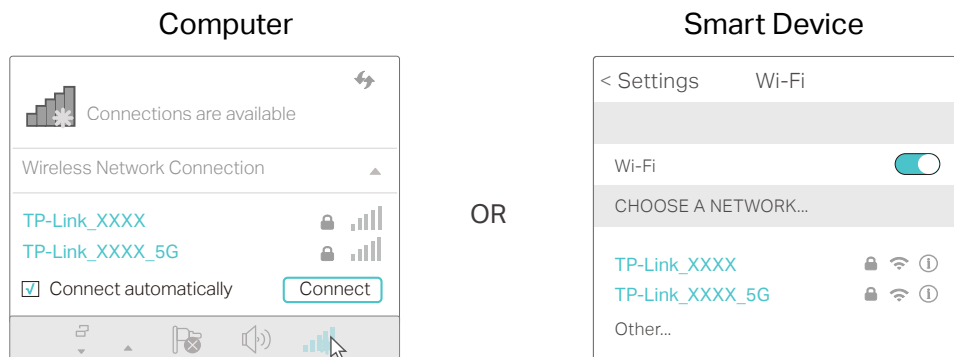

- **Method 3: Use the WPS button**

Wireless devices that support WPS, including Android phones, tablets, most USB network cards, can be connected to your router through this method.

Note:

- WPS is not supported by iOS devices.
 - The WPS function cannot be configured if the wireless function of the router is disabled. Also, the WPS function will be disabled if your wireless encryption is WEP. Please make sure the wireless function is enabled and is configured with the appropriate encryption before configuring the WPS.
- 1) Tap the WPS icon on the device's screen. Here we take an Android phone as an example.
 - 2) Immediately press the WiFi/WPS button on your router.

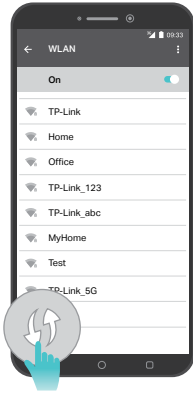

Close to

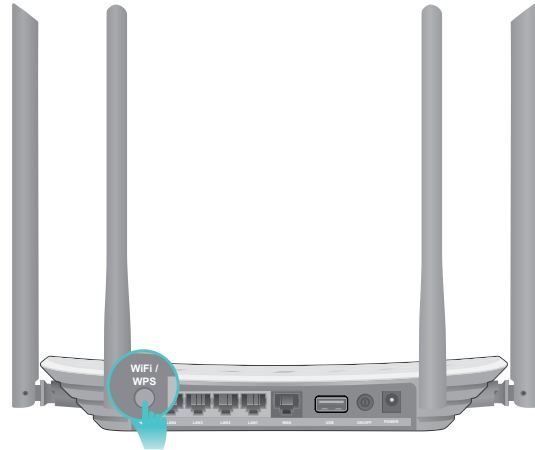

Chapter 3

Log In to Your Router

With a web-based utility, it is easy to configure and manage the router. The web-based utility can be used on any Windows, Macintosh or UNIX OS with a Web browser, such as Microsoft the Internet Explorer, Mozilla Firefox or Apple Safari.

Follow the steps below to log in to your router.

1. Set up the TCP/IP Protocol in [Obtain an IP address automatically](#) mode on your computer.
2. Visit <http://tplinkwifi.net>, and create a login password for secure management. Then click [Let's Get Started](#) to log in.

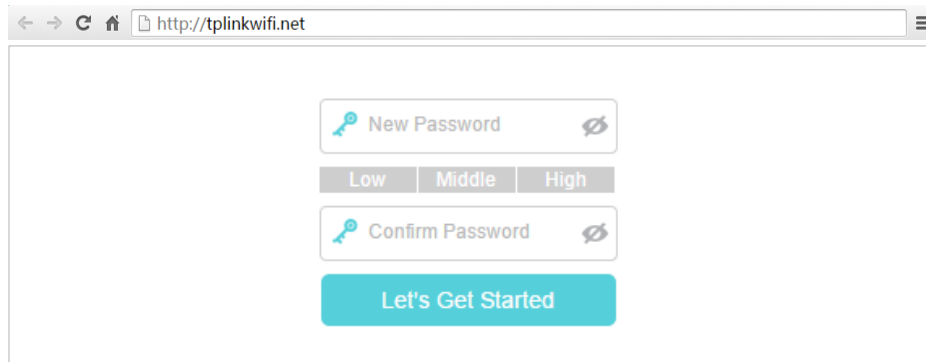
A screenshot of a web browser window showing the login page for TPLINKWiFi. The address bar displays "http://tplinkwifi.net". The page content includes a "New Password" input field with a key icon and a toggle for visibility. Below it are three buttons labeled "Low", "Middle", and "High" for password strength selection. A "Confirm Password" input field with a key icon and a toggle for visibility is positioned below the strength buttons. At the bottom of the form is a prominent teal button labeled "Let's Get Started".

Note:

If the login window does not appear, please refer to the [FAQ](#) section.

Chapter 4

Set Up Internet Connection

This chapter introduces how to connect your router to the internet. The router is equipped with a web-based Quick Setup wizard. It has necessary ISP information built in, automates many of the steps and verifies that those steps have been successfully completed. Furthermore, you can also set up an IPv6 connection if your ISP provides IPv6 service.

It contains the following sections:

- [Use Quick Setup Wizard](#)
- [Manually Set Up Your Internet Connection](#)
- [Set Up an IPv6 Internet Connection](#)
- [More Operation Modes](#)

4.1. Use Quick Setup Wizard

The Quick Setup Wizard will guide you through the process to set up your router.

 **Tips:**

If you need the IPv6 internet connection, please refer to the section of [Set Up an IPv6 Internet Connection](#).

Follow the steps below to set up your router.

1. Visit <http://tplinkwifi.net>, and log in with the password you set for the router.
2. Click **Quick Setup** on the top of the page. Then follow the step-by-step instructions to connect your router to the internet.

 **Note:**

If you have changed the preset wireless network name (SSID) and wireless password during the Quick Setup process, all your wireless devices must use the new SSID and password to connect to the router.

4.2. Manually Set Up Your Internet Connection

In this part, you can check your current internet connection settings. You can also modify the settings according to the service information provided by your ISP.

Follow the steps below to check or modify your internet connection settings.

1. Visit <http://tplinkwifi.net>, and log in with the password you set for the router.
2. Go to **Basic > Internet**.
3. Select your internet connection type from the drop-down list.

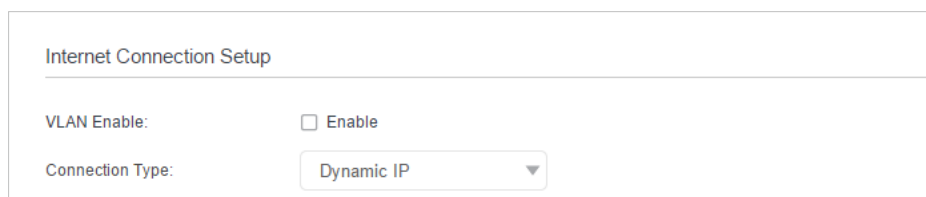

The screenshot shows a web interface titled "Internet Connection Setup". It contains two settings: "VLAN Enable" with an unchecked checkbox labeled "Enable", and "Connection Type" with a dropdown menu currently set to "Dynamic IP".

 **Note:**

If you are unsure of what your connection type is, you can consult your ISP. Since different connection types require different cables and connection information, you can also refer to the demonstrations in Step 4 to determine your connection type.

4. Follow the instructions on the page to continue the configuration. Parameters on the images are used for demonstration only.

- 1) If you choose **Dynamic IP**, you just need to click **Save** to make the settings effective. Dynamic IP users are usually equipped with a cable TV or fiber cable.

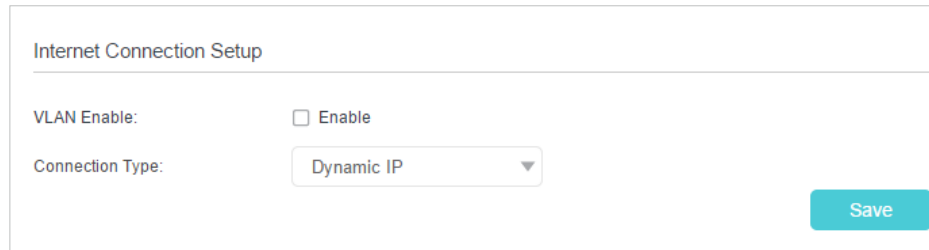

Internet Connection Setup

VLAN Enable: Enable

Connection Type:

- 2) If you choose **Static IP**, enter the information provided by your ISP in the corresponding fields.

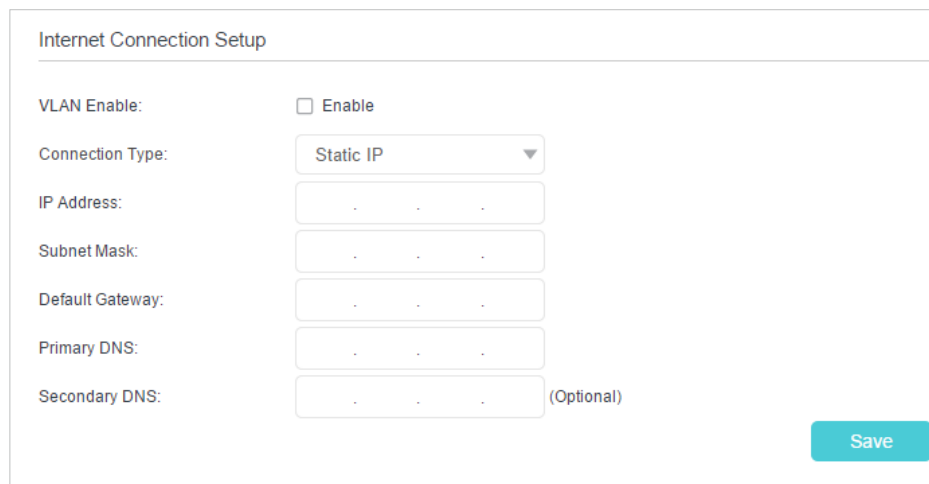

Internet Connection Setup

VLAN Enable: Enable

Connection Type:

IP Address:

Subnet Mask:

Default Gateway:

Primary DNS:

Secondary DNS:

(Optional)

- 3) If you choose **PPPoE**, enter the **Username** and **Password** and choose **Secondary Connection** provided by your ISP. Different parameters are needed according to the Secondary Connection type you have chosen. PPPoE users usually have DSL cable modems.

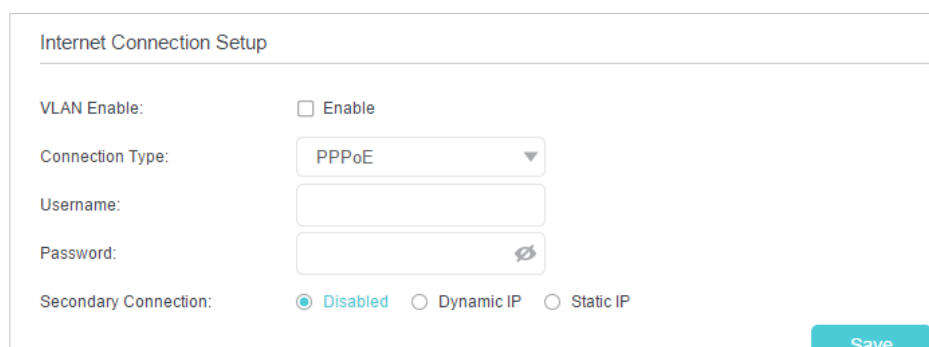

Internet Connection Setup

VLAN Enable: Enable

Connection Type:

Username:

Password:

Secondary Connection: Disabled Dynamic IP Static IP

- 4) If you choose **L2TP**, enter the **Username** and **Password**, and select the **IP Address Type** provided by your ISP. Different parameters are needed according to the IP address type you selected.

The screenshot shows the 'Internet Connection Setup' form. The 'VLAN Enable' checkbox is unchecked. The 'Connection Type' dropdown is set to 'L2TP'. The 'Username' and 'Password' fields are empty. The 'IP Address Type' radio buttons have 'Dynamic IP' selected. The 'Server IP Address/Name' field is empty. A 'Save' button is located at the bottom right.

- 5) If you choose [PPTP](#), enter the [Username](#) and [Password](#), and select the [IP Address Type](#) provided by your ISP. Different parameters are needed according to the IP address type you selected.

The screenshot shows the 'Internet Connection Setup' form. The 'VLAN Enable' checkbox is unchecked. The 'Connection Type' dropdown is set to 'PPTP'. The 'Username' and 'Password' fields are empty. The 'IP Address Type' radio buttons have 'Dynamic IP' selected. The 'Server IP Address/Name' field is empty. A 'Save' button is located at the bottom right.

5. Click [Save](#) to make the settings effective, and you can refer to [Test Internet Connectivity](#) to test the Internet connection.

Note:

It may take 1-2 minutes to make the settings effective.

Tips:



1. You can check your internet connection by clicking [Network Map](#) on the left of the page.
2. If you use [Dynamic IP](#) and [PPPoE](#) and you are provided with any other parameters that are not required on the page, please go to [Advanced > Network > Internet](#) to complete the configuration.
3. If you still cannot access the internet, refer to the [FAQ](#) section for further instructions.

4.3. Set Up an IPv6 Internet Connection

If your ISP provides information about one of the following IPv6 internet connection types: [PPPoE](#), [Dynamic IP\(SLAAC/DHCPv6\)](#), and [Static IP](#), you can manually set up an IPv6 connection.

If your ISP provides an IPv4-only connection or IPv6 tunnel service, permit IPv6 connection by referring to [Set Up the IPv6 Tunnel](#).

1. Visit <http://tplinkwifi.net>, and log in with the password you set for the router.
2. Go to [Advanced](#) > [Network](#) > [Internet](#).

Internet Connections				
WAN Interface Name	VLAN ID	Status	Operation	Modify
ipoe_eth_0_2_d	N/A	WAN Disconnected	Connect	 

3. Select your WAN Interface Name ([Status](#) should be [Connected](#)) and click the  (edit) icon.
4. Scroll down the page, enable [IPv6](#), and configure the IPv6 parameters.

IPv6:	<input checked="" type="checkbox"/> Enable
Addressing Type:	<input type="text" value="SLAAC"/>
IPv6 Default Gateway:	<input type="text" value="Current Connection"/>

- [Addressing Type](#): Consult your ISP for the addressing type ([DHCPv6](#) or [SLAAC](#)). [SLAAC](#) is the most commonly used addressing type.
- [IPv6 Gateway](#): Keep the default setting as [Current Connection](#).

Note: If your ISP has provided the IPv6 address, click [Advanced](#) to reveal more settings. You can check the detailed settings of IPv6 and enter the parameters provided by your ISP.

5. Click [Save](#) to make the settings effective. Now IPv6 service is available for your network.

4. 4. More Operation Modes

The router supports two more operation modes: Access Point mode and Range Extender mode. You can change the operation mode according to your needs.

4. 4. 1. Configure the Router in Access Point Mode

In Access Point mode, the device can be connected to a wired network and transform the wired access into wireless one to extend the wireless coverage of your existing network. Advanced functions like NAT, Parental Controls and QoS are not supported in this mode.

If you already have a wired router, you can use this mode. To switch to Access Point mode:

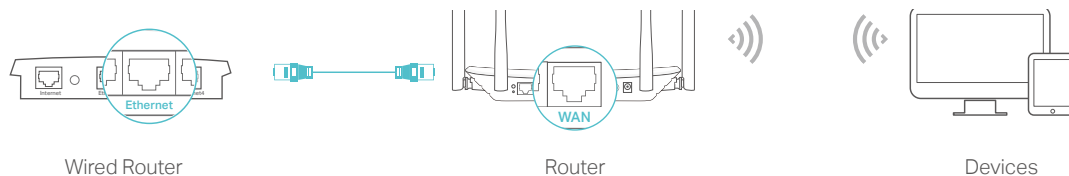

1. Connect the router's WAN port to your wired router's Ethernet port via an Ethernet cable as shown above. And power on the router.
2. Connect a computer to the router via an Ethernet cable or wirelessly by using the SSID (network name) and Wireless Password printed on the label at the bottom of the router.
3. Visit <http://tplinkwifi.net>, and log in with the password you set for the router.
4. Go to **Settings** or **Advanced > Operation Mode**, select **Access Point** and click **Save**. Log in to the router via <http://tplinkwifi.net> after the router reboots.
5. Go to **Quick Setup** or **Settings > Wireless > Wireless Settings** and set the network name(SSID) and passwords for the wireless network.

Now, you can connect to the SSID and enjoy your existing network.

4. 4. 2. Configure the Router in Range Extender Mode

In Range Extender mode, the device can copy and reinforce the existing wireless signal to extend the coverage of the signal, especially for a large space to eliminate signal-blind corners. Advanced functions like NAT, Parental Controls and QoS are not supported in this mode.

To switch to Range Extender mode:

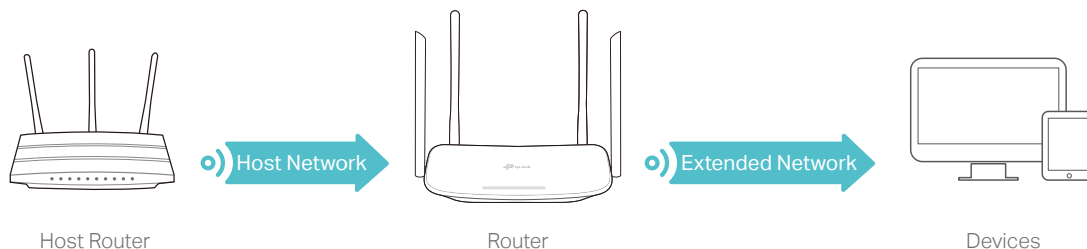

1. Place the router next to your host router and power it on.
2. Connect a computer to the router via an Ethernet cable or wirelessly by using the SSID (network name) and Wireless Password printed on the label at the bottom of the router.
3. Visit <http://tplinkwifi.net>, and log in with the password you set for the router.

4. Go to [Settings](#) or [Advanced > Operation Mode](#), select [Range Extender](#) and click [Save](#). Log in to the router via <http://tplinkwifi.net> after the router reboots.

5. Configure the basic settings of the wireless network.

- **Method 1: Use Quick Setup wizard**

Go to [Quick Setup](#) to connect to the host network and specify your extended wireless network name(SSID).

- **Method 2: Manually configure the network connection**

➤ **To connect to the host network:**

1) Go to [Settings > Wireless > Connect to Network](#), select the wireless band ([2.4GHz](#) or [5GHz](#)) you want to connect to.

2) Make sure the [Enable](#) check box of [Wireless Network](#) is selected, and then click [Scan](#) to detect all available wireless networks.

Wireless Network: 2.4GHz | 5GHz

Network Roaming: Enable

Wireless Network: Enable

Network Name (SSID): [Scan](#)

MAC Address:

Security: No Security WPA/WPA2 Personal WEP

[Save](#)

📌 **Tips:**

1. You can also enter the SSID and MAC address of the host network in the corresponding fields and select the security settings of the host network.
2. You can connect to both 2.4GHz and 5GHz wireless networks for a dual-band router, here we use the 2.4GHz network as an example.

3) Select the wireless network you want to connect to by clicking the connect icon in the [Connect](#) column. Once the host network is selected, the SSID and security settings of that network will be automatically filled in.

AP List

Refresh

ID	MAC Address	SSID	Signal Strength	Channel	Encryption	Connect
1	AC-84-C8-C8-D9-82	Tadaxaa	82	3	Encrypted	
2	8C-80-83-79-52-82	TP-Link_5282	52	9	Encrypted	
3	00-0A-22-51-25-69	HC220-G1_UE	50	5	Encrypted	
4	AC-84-C8-C8-D9-88	TP-Link_D988	48	3	Encrypted	
5	8C-80-83-79-52-22	Internet_5522_2.4GHz	46	3	Encrypted	
6	AC-84-C8-89-52-40	MeetingRoom_2.4G	46	8	Encrypted	
7	FA-95-EA-8A-C2-82	香大港	44	1	Encrypted	
8	AC-84-C8-1B-8A-D0	MeetingRoom_2.4G	42	1	Encrypted	

1 2 3 4 5

Back

- 4) Enter the **Password** of the host network you selected if it has one, and click **Save** to make the settings effective.

Wireless Network: 2.4GHz | 5GHz

Network Roaming: Enable

Wireless Network: Enable

Network Name (SSID):

MAC Address:

Security: No Security WPA/WPA2 Personal WEP

Version: WPA-PSK WPA2-PSK

Encryption: TKIP AES

Password:

Note: You can also enable the **Network Roaming** function. Once the network roaming is enabled, the wireless clients can roam between the Range Extender router and Root AP automatically according to the wireless environment, and you do not need to specify the settings of **Extended Network**.

➤ **To specify the extended network:**

- 1) Go to **Settings > Wireless > Extended Network**, and configure the basic settings of the extended network.

Extended Network Settings 2.4GHz | 5GHz

Enable Wireless Radio

Network Name (SSID): Hide SSID

Security:

Version: Auto WPA2-PSK

Encryption: Auto TKIP AES

Password:

Transmit Power: Low Middle High

- **Network Name (SSID):** Enter a new SSID (up to 32 characters long) or just use the SSID of the default name copied from the host network. This field is case-sensitive. Do not select **Hide SSID** unless you want the client devices to join the network manually.
 - **Security:** Select one of the security options and configure the corresponding settings for the extended wireless network.
 - **No Security** - This option disables the wireless security.
 - **WPA/WPA2(Recommended)** - Select this option to enable the wireless security. This is highly recommended to protect the wireless network from unauthorized access. And then you can select a security version and encryption type.
 - **WEP** - This option is the most basic form of wireless security that can be used if your client devices can only access wireless using WEP (Wired Equivalent Privacy).
 - **Transmit Power:** Select Low, Middle, or High to specify the data transmit power. The default and recommended setting is **High**.
- 2) Click **Save** to make the settings effective.

Now, you can connect to the SSID and enjoy the extended network.

Chapter 5

USB Settings

This chapter describes how to use the USB port to share files and media from the USB storage devices over your home network locally, or remotely through the internet.

You can also learn how to get wireless internet access through 3G/4G mobile network.

The router supports USB external flash drives and hard drives.

It contains the following sections:

- [Access the USB Storage Device](#)
- [Media Sharing](#)
- [3G/4G Settings](#)

5. 1. Access the USB Storage Device

Insert your USB storage device into the router's USB port and then access files stored there locally or remotely.

🔗 Tips:

1. If you use USB hubs, make sure no more than 4 devices are connected to the router.
2. If the USB storage device requires using bundled external power, make sure the external power has been connected.
3. If you use a USB hard drive, make sure its file system is FAT32, exFat, NTFS or HFS+.
4. Before you physically disconnect a USB device from the router, safely remove it to avoid data damage: Go to [Advanced](#) > [USB Sharings](#) > [USB Storage Devices](#) and click [Remove](#).

5. 1. 1. Access the USB Device Locally

Insert your USB storage device into the router's USB port and then refer to the following table to access files stored on your USB storage device.

Windows Computer

➤ Method 1:

Go to [Computer](#) > [Network](#), then click the Network Server Name ([Archer_model number](#) by default) in the [Computer](#) section.

📌 Note:

Operations in different systems are similar. Here we take Windows 7 as an example.

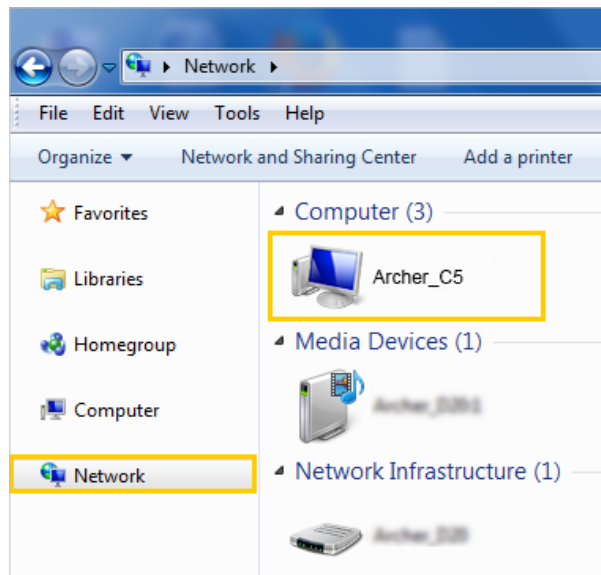

Windows
Computer

➤ Method 2:

Open the [Windows Explorer](#) (or go to [Computer](#)) and type the server address `\\tplinkwifi.net` or `ftp://tplinkwifi.net` in the address bar, then press [Enter](#).

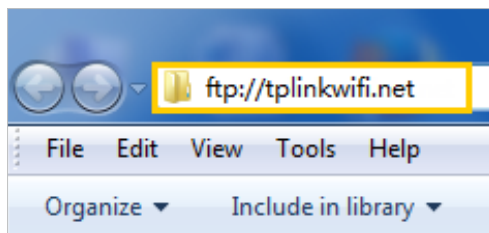

Mac

- 1) Select [Go](#) > [Connect to Server](#).
- 2) Type the server address `smb://tplinkwifi.net`.
- 3) Click [Connect](#).

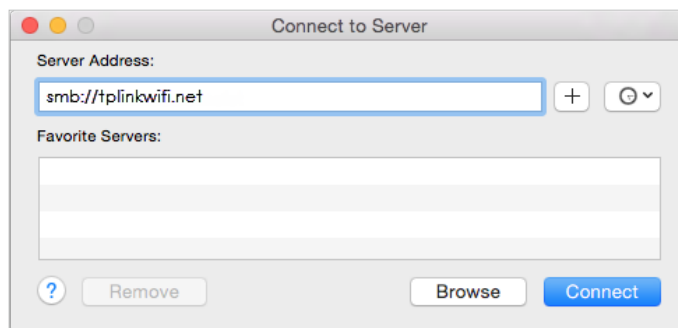

- 4) When prompted, select the [Guest](#) radio box. (If you have set up a username and a password to deny anonymous access to the USB disks, you should select the [Registered User](#) radio box. To learn how to set up an account for the access, refer to [To set up authentication for data security](#).)

Smart
Device

Use a third-party app for network files management.

📌 Tips:

You can also access your USB disk by using your Network/Media Server Name as the server address. Refer to [To customize the address of the USB disk](#) to learn more.

5. 1. 2. Access the USB Device Remotely

You can access your USB disk outside the local area network. For example, you can:

- Share photos and other large files with your friends without logging in to (and paying for) a photo-sharing site or email system.
- Get a safe backup for the materials for a presentation.
- Remove the files on your camera's memory card from time to time during the journey.

Note:

If your ISP assigns a private WAN IP address (such as 192.168.x.x or 10.x.x.x), you cannot use this feature because private addresses are not routed on the Internet.

Follow the steps below to configure remote access settings.

1. Visit <http://tplinkwifi.net>, and log in with the password you set for the router.
2. Go to **Advanced** > **USB Sharing** > **USB Storage Device**, and locate the **Sharing Settings** section.
3. Select the **FTP (via Internet)** check box, and then click **Save**.

Sharing Settings

Network/Media Server Name:

Enable	Access Method	Access Address	Port
<input checked="" type="checkbox"/>	Media Server	--	--
<input checked="" type="checkbox"/>	Network Neighborhood	\\Archer_C5	--
<input checked="" type="checkbox"/>	FTP	ftp://192.168.0.1:21	<input type="text" value="21"/>
<input checked="" type="checkbox"/>	FTP(via Internet)	ftp://0.0.0.0:21	21

4. Refer to the following table to access your USB disk remotely.

Computer	<ol style="list-style-type: none"> 1) Open the Windows Explorer (or go to Computer, only for Windows users) or open a web browser. 2) Type the server address in the address bar: Type in ftp://<WAN IP address of the router>:<port number> (such as ftp://59.40.2.243:21). If you have specified the domain name of the router, you can also type in ftp://<domain name>:<port number> (such as ftp://MyDomainName:21)  <ol style="list-style-type: none"> 3) Press Enter on the keyboard. 4) Access with the username and password you set in To Set Up Authentication for Data Security. <p>Tips: You can also access the USB disk via a third-party app for network files management, which can resume broken file transfers.</p>
	Smart Device

Tips:

Refer to [Set Up a Dynamic DNS Service Account](#) to learn how to set up a domain name for you router.

5.1.3. View USB Storage Device

The router contains one USB port, you can use it to connect a USB storage device such as a flash drive or hard drive.

➤ **To view USB Storage Device Status**

1. Visit <http://tplinkwifi.net>, then log in with the password you set for the router.
2. Go to [Advanced > USB Sharing > USB Storage Device](#) or [Basic > USB Sharing > USB Storage Device](#) page.

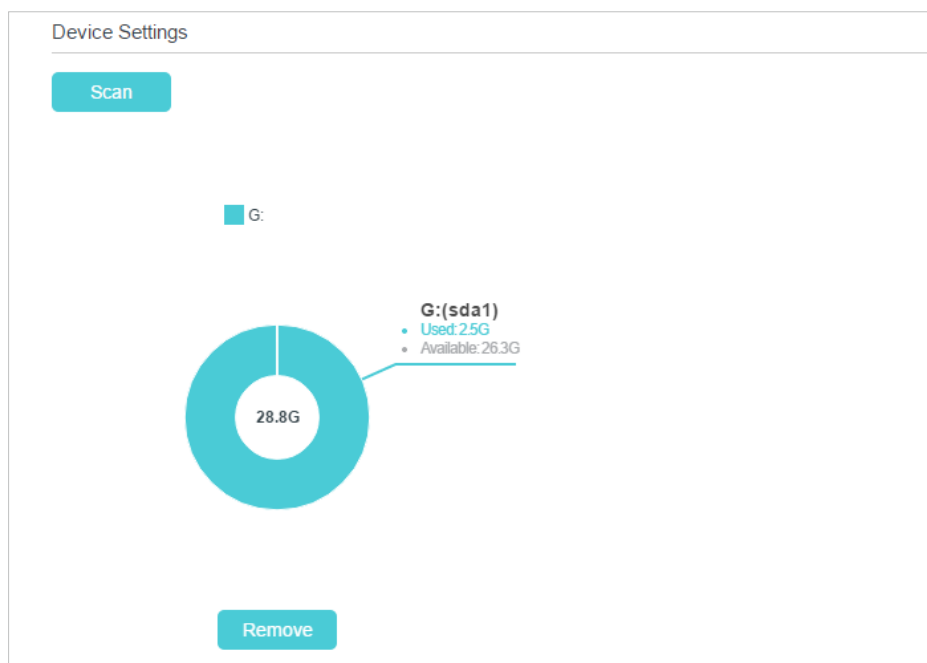

- **Scan:** Usually, the router will automatically detect any newly inserted USB device. If you find that your USB device is not displayed in the **Device Settings** section, you can click **Scan** to refresh the web page with the updated information.
- **Remove:** Click this button to safely take the USB device offline before you remove the USB device physically.
- **Doughnut Chart:** Display the basic information of the USB storage device, including the total space and available space when the pointer is over the chart.
You can click the doughnut chart to hide the USB device from access, which will turn the chart into a gray one.

5.1.4. Customize the Access Settings

By default, all the network clients can access all folders on your USB disk. You can customize your sharing settings by setting a sharing account, sharing specific contents and setting a new sharing address on the router's web management page.

1. Visit <http://tplinkwifi.net>, and log in with the password you set for the router.
2. Go to **Advanced** > **USB Sharing** > **USB Storage Device** page.

➤ To Customize the Address of the USB Disk

You can customize the server name and use the name to access your USB disk.

1. In the **Sharing Settings** section, make sure **Network Neighborhood** is selected, and enter a Network/Media Server Name as you like, such as **MyShare**, then click **Save**.

Sharing Settings

Network/Media Server Name:

Enable	Access Method	Access Address	Port
<input checked="" type="checkbox"/>	Media Server	--	--
<input checked="" type="checkbox"/>	Network Neighborhood	\\MyShare	--
<input checked="" type="checkbox"/>	FTP	ftp://192.168.0.1:21	<input type="text" value="21"/>
<input checked="" type="checkbox"/>	FTP(via Internet)	ftp://0.0.0.0:21	21

- Now you can access the USB disk by visiting `\\MyShare` (for Windows) or `smb://MyShare` (for Mac).

➤ **To Only Share Specific Content**

- Focus on the **Folder Sharing** section. Turn off **Share All**, then click **Add** to add a new sharing folder.

Folder Sharing

Share All:

<input type="checkbox"/>	ID	Folder Name	Folder Path	Media Sharing	Volume Name	Status	Modify
	--	--	--	--	--	--	--

Volume Name:

Folder Path:

Folder Name:

Enable Authentication

Enable Write Access

Enable Media Sharing

- Select the **Volume Name** and **Folder Path**, then enter a **Folder Name** as you like.
- Decide the way you share the folder:
 - Enable Authentication:** By default, authentication is disabled for the folder sharing, if you select this check box, you will be required to log in to the Sharing

Account to access the USB disk. Refer to [To Set Up Authentication for Data Security](#) to learn more.

- **Enable Write Access:** If you select this check box, network clients can modify this folder.
- **Enable Media Sharing:** Select this check box to enable media sharing for this folder, and you can view photos, play music and watch movies stored on the USB disk directly from DLNA-supported devices. Refer to [3G/4G Settings](#) to learn more.

4. Click **Save** to make the settings effective.



 **Tips:**

The router can share 8 folders at most. You can click  on the page to detach the corresponding folder you do not want to share.

Folder Sharing

Share All:

[+ Add](#) [- Delete](#)

	ID	Folder Name	Folder Path	Media Sharing	Volume Name	Status	Modify
<input type="checkbox"/>	1	HelloWorld	G:/Hello World	Off	sda1		 

➤ **To Set Up Authentication for Data Security**

You can set up authentication for your USB device so that network clients will be required to enter the username and password when accessing the USB disk.

1. In the [Sharing Account](#) section, choose [Use Default Account](#) or [Use New Account](#). The user name is `admin` and the password is the login password for the default account. If you choose [Use New Account](#), you can create a new username and password.

Sharing Account

Content sharing requires a sharing account. You can use the login account or create a new one.

Account: [Use Default Account](#)
 [Use New Account](#)

Username:

Password: (Same as Login Password)

[Save](#)

 **Note:**

For Windows users, do not set the sharing username the same as the Windows username. Otherwise, Windows credential mechanism may cause the following problems:

- If the sharing password is also the same as the Windows password, authentication will not work since the Windows system will automatically use its account information for USB access.
- If the sharing password is different from the Windows password, the Windows system will be unable to remember your credentials and you will always be required to enter the sharing password for USB access.

2. Enable authentication to apply the account you just set.

- If you leave **Share All** enabled, turning on **Enable Authentication** will enable authentication for all folders.

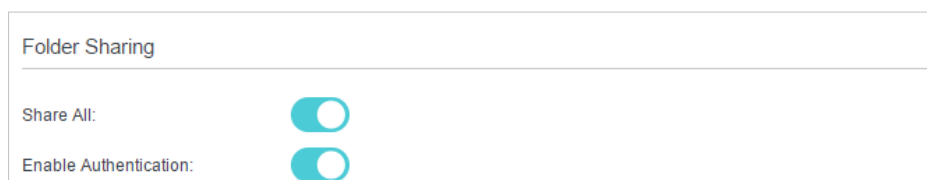

- If **Share All** is disabled, you can select **Enable Authentication** to apply authentication to specific folders.

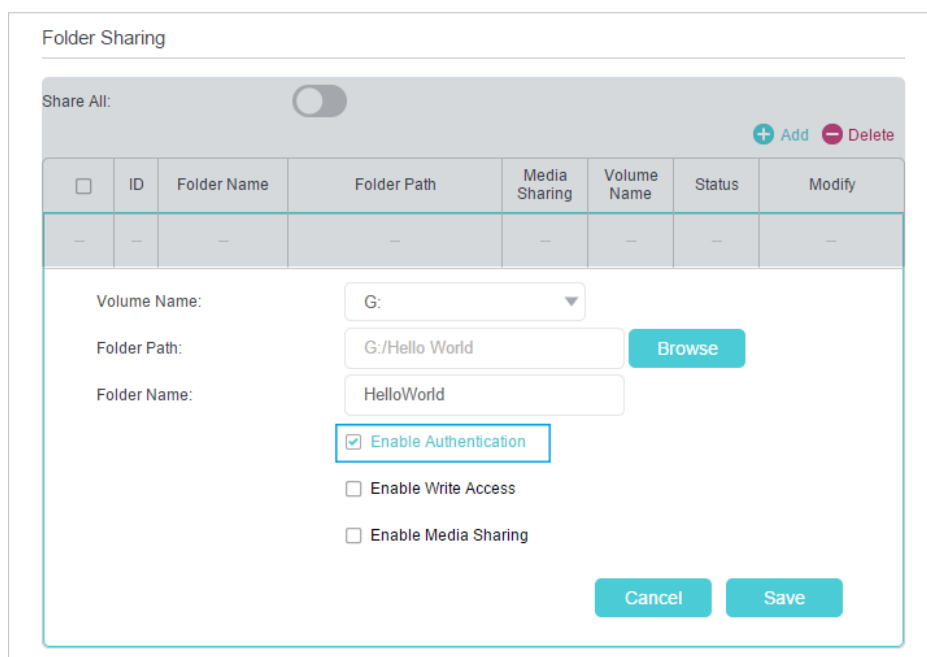

Note:

Due to Windows credential mechanism, you might be unable to access the USB disk after changing Authentication settings. Please log out from the Windows and try to access again. Or you can change the address of the USB disk by referring to [To Customize the Address of the USB Disk](#).

5.2. Media Sharing

The feature of **Media Sharing** allows you to view photos, play music and watch movies stored on the USB disk directly from DLNA-supported devices, such as your computer, tablet and PS2/3/4.

1. When your USB disk is inserted into the router, your DLNA-supported devices (such as your computer and pad) connected to the router can detect and play the media files on the USB disks.
2. Refer to the following table for detailed instructions.

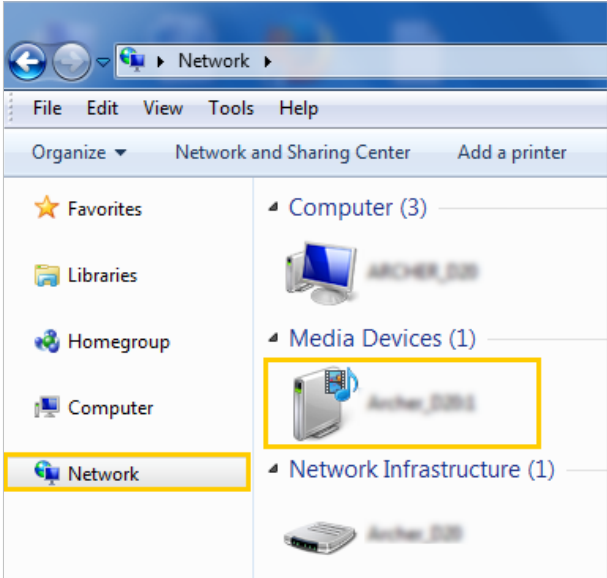
Windows Computer	<ul style="list-style-type: none"> • Go to Computer > Network, then click the Media Server Name (Archer_model number by default) in the Media Devices section. <p>Note: Here we take Windows 7 as an example.</p>  <p>The screenshot shows the Windows 7 Network and Sharing Center. The left sidebar has 'Network' selected. The main area shows 'Computer (3)', 'Media Devices (1)', and 'Network Infrastructure (1)'. Under 'Media Devices (1)', a device named 'Archer_2011' is highlighted with a yellow box.</p>
Smart Device	<ul style="list-style-type: none"> • Use a third-party DLNA-supported player.

5.3. 3G/4G Settings

The router can be used as a 3G/4G wireless router if you have a 3G/4G USB modem. You can use your 3G/4G network as a backup solution for Internet access.

➤ To Set the Router as a Backup Solution for Internet Access

Using 3G/4G network as a backup solution for Internet access, your router will be directly connected to the 3G/4G network when the original network service fails. When the WAN port is not connected, 3G/4G network is the only way to access the Internet.

Follow the steps below to set your 3G/4G network as a backup for Internet access:

1. Plug your USB modem into the USB port of your router.
2. Visit <http://tplinkwifi.net>, then log in with the password you set for the router.

3. Go to **Advanced > USB Sharing > 3G/4G Settings**, and select the check box of **Enable 3G/4G as a backup solution for Internet access**.

3G/4G Settings

Note: 3G or 4G access is unavailable in the current operation mode. Please enable 3G/4G backup or change the operation mode to 3G/4G Router mode.

Enable 3G/4G as a backup solution for Internet access

3G/4G USB Modem: **Unplugged**

PIN Status: **Unknown**

Connection Status: **Disconnected**

[> 3G/4G USB Modem Settings](#) Save

4. Verify that your **3G/4G USB Modem** is successfully identified.

■ Note:

The 3G/4G USB modem will not be identified if it is incompatible with the router. Find the 3G/4G Compatibility List on the web page: <http://www.tp-link.com/en/comp-list.html>. If your USB modem is incompatible, contact our technical support.

5. Click **Save** to make the settings effective.

Chapter 6

Parental Controls

This function allows you to block inappropriate, explicit and malicious websites, and control access to specified websites at specified time.

I want to:

Control what types of websites my children or other home network users can visit and the time of day they are allowed to access the internet.

For example, I want to allow my children's devices (e.g. a computer or a tablet) to access only www.tp-link.com and Wikipedia.org from 18:00 (6 PM) to 22:00 (10 PM) on the weekdays and not other time.

How can I do that?

1. Visit <http://tplinkwifi.net>, and log in with the password you set for the router.
2. Go to [Basic > Parental Controls](#) or [Advanced > Parental Controls > Parental Controls](#), and enable [Parental Controls](#).



3. Click [Add](#), and then click [Scan](#) to select the connected device to be controlled. Or, enter the [Device Name](#) and [MAC Address](#) manually.

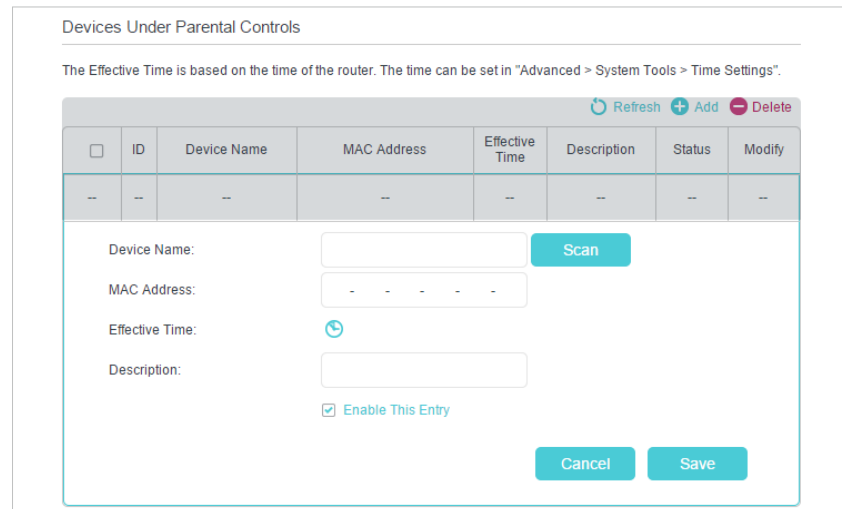

4. Click the  icon to set the Effective Time. Drag the cursor over the appropriate cell(s) and click [OK](#).

System Time: 01/01/2016 01:12:39

	Sun	Mon	Tue	Wed	Thu	Fri	Sat
0:00							
1:00							
2:00							
3:00							
4:00							
5:00							
6:00							
7:00							
8:00							
9:00							
10:00							
11:00							
12:00							
13:00							
14:00							
15:00							
16:00							
17:00							
18:00		Effective Time	Effective Time	Effective Time	Effective Time	Effective Time	
19:00		Effective Time	Effective Time	Effective Time	Effective Time	Effective Time	
20:00		Effective Time	Effective Time	Effective Time	Effective Time	Effective Time	
21:00		Effective Time	Effective Time	Effective Time	Effective Time	Effective Time	
22:00		Effective Time	Effective Time	Effective Time	Effective Time	Effective Time	
23:00							
24:00							

Effective Time

Reset OK

- Enter a [Description](#) for the entry, keep the [Enable This Entry](#) check box selected, and then click [Save](#).
- Enable [Content Restriction](#), and select [Whitelist](#) as the restriction policy.

Content Restriction

Content Restriction:

Restriction Policy: Blacklist Whitelist

+ Add a New Keyword

Save

Tips:

- With [Blacklist](#) selected, the controlled devices cannot access any websites containing the specified keywords during the Effective Time period.
- With [Whitelist](#) selected, the controlled devices can only access websites containing the specified keywords during the Effective Time period.

- Click [Add a New Keyword](#) and enter "www.tp-link.com" and "Wikipedia.org" as the keywords and click [Save](#).

Content Restriction

Content Restriction:

Restriction Policy: Blacklist Whitelist

+ Add a New Keyword

www.tp-link.com - Wikipedia.org -

Save

8. You can add up to 32 keywords for either Blacklist or Whitelist.

Below are some sample entries for your reference.

- **For Whitelist:** Enter a web address (e.g. wikipedia.org) to allow access only to its related websites. If you wish to block all Internet browsing access, do not add any keyword to the [Whitelist](#).
- **For Blacklist:** Specify a web address (e.g. wikipedia.org), a web address keyword (e.g. wikipedia) or a domain suffix (e.g. .edu or .org) to block access only to the websites containing that keyword or suffix.

Done!

Now you can control your children's internet access as needed.

Chapter 7

Bandwidth Control

This chapter describes how to use the Bandwidth Control function to control the bandwidth by configuring rules for limiting various data flows. In this way, the network bandwidth can be reasonably distributed and utilized.

It contains the following sections:

- [Configure the Bandwidth Control](#)
- [Controlling Rules](#)

7.1. Configure the Bandwidth Control

Bandwidth Control allows you to configure the Upstream Bandwidth and Downstream Bandwidth of the network, follow the steps below to configure the bandwidth.

1. Visit <http://tplinkwifi.net>, and log in with the password you set for the router.
2. Go to [Advanced > Bandwidth Control](#), and enable [Bandwidth Control](#).
3. Input the total upload and download speed through the WAN port in the [Total Upstream Bandwidth](#) and [Total Downstream Bandwidth](#) field. For optimal bandwidth control, please consult your ISP for the total allowed bandwidth for upstream and downstream.

4. Click [Save](#) to make the settings effective.

7.2. Controlling Rules

To add a new rule for the Bandwidth Control:

1. Click [Add](#).

2. Enter a range of IP addresses and port numbers to be controlled.

IP Range: The IP range can be a single IP address or IP address range according to your needs. If you set the IP Range to a single IP address, the computer with this IP address will get independent given bandwidth. If you set the IP Range to an IP address range, all computers in the range will share the given bandwidth.

Port Range: Enter a range of port numbers to be controlled.

3. Select the protocol type for this rule.
4. Select a priority level for this rule. 1 is the highest priority level and 8 is the lowest priority level. The total upload and download bandwidth will be allocated to guarantee the minimal rate of all bandwidth control rules.
5. Enter the minimum and maximum upload bandwidth and download bandwidth through the WAN port.
6. Select the **Enable This Entry** check box.
7. Click **Save** to make the settings effective.

Chapter 8

Network Security

This chapter guides you on how to protect your home network from unauthorized users by implementing network security functions. You can block or allow specific client devices to access your wireless network using MAC Filtering, or using Access Control for wired and wireless networks, or you can prevent ARP spoofing and ARP attacks by using IP & MAC Binding.

This chapter contains the following sections:

- [Firewall & DoS Protection](#)
- [Service Filtering](#)
- [Access Control](#)
- [IP & MAC Binding](#)

8. 1. Firewall & DoS Protection

The SPI (Stateful Packet Inspection) Firewall and DoS (Denial of Service) Protection protect the router from cyber attacks.

The SPI Firewall can prevent cyber attacks and validate the traffic that is passing through the router based on the protocol. This function is enabled by default, and it is recommended to keep the default settings.

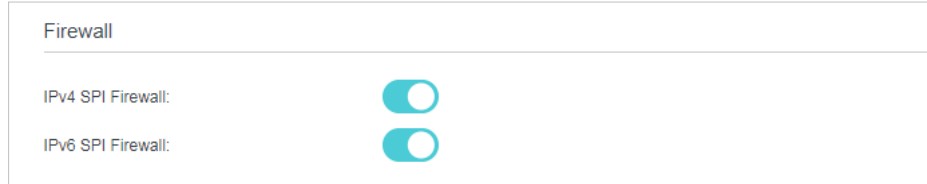

DoS Protection can protect your home network against DoS attacks from flooding your network with server requests. Follow the steps below to configure DoS Protection.

1. Visit <http://tplinkwifi.net>, and log in with the password you set for the router.
2. Go to **Advanced > Security > Firewall & DoS Protection**.

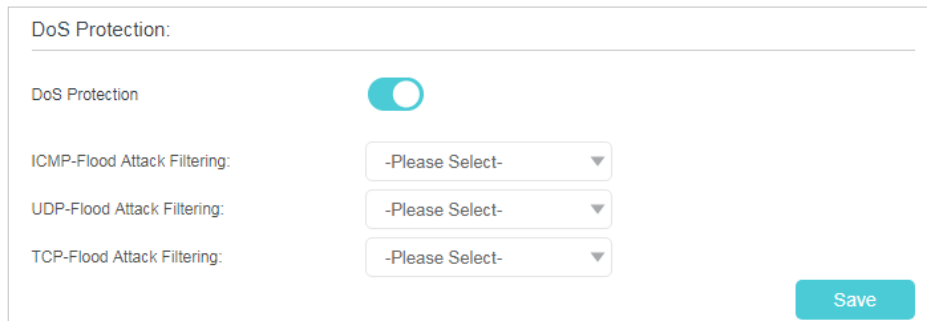

3. Enable **DoS Protection**.
4. Set the protection level (**Low**, **Middle** or **High**) for **ICMP-Flood Attack Filtering**, **UDP-Flood Attack Filtering** and **TCP-Flood Attack Filtering**.
 - **ICMP-Flood Attack Filtering** - Enable to prevent the ICMP (Internet Control Message Protocol) flood attack.
 - **UDP-Flood Attack Filtering** - Enable to prevent the UDP (User Datagram Protocol) flood attack.
 - **TCP-Flood Attack Filtering** - Enable to prevent the TCP (Transmission Control Protocol) flood attack.
5. Click **Save**.

 **Tips:**

1. The level of protection is based on the number of traffic packets. You can specify the level under **DoS Protection Level Settings**.

Dos Protection Level Settings

ICMP-Flood Protection Level:	Low:	<input type="text" value="1200"/>	(5-3600) packets/sec
	Middle:	<input type="text" value="2400"/>	(5-3600) packets/sec
	High:	<input type="text" value="3600"/>	(5-3600) packets/sec
UDP-Flood Protection Level:	Low:	<input type="text" value="1200"/>	(5-3600) packets/sec
	Middle:	<input type="text" value="2400"/>	(5-3600) packets/sec
	High:	<input type="text" value="3600"/>	(5-3600) packets/sec
TCP-SYN-Flood Protection Level:	Low:	<input type="text" value="1200"/>	(5-3600) packets/sec
	Middle:	<input type="text" value="2400"/>	(5-3600) packets/sec
	High:	<input type="text" value="3600"/>	(5-3600) packets/sec

Save

- The protection will be triggered immediately when the number of packets exceeds the preset threshold value, and the vicious host will be displayed in the [Blocked DoS Host List](#).

Blocked DoS Host List

Host Number: 0 [Refresh](#) [Delete](#)

<input type="checkbox"/>	ID	IP Address	MAC Address
--	--	--	--

8. 2. Service Filtering

With Service Filtering, you can prevent certain users from accessing the specified service, and even block internet access completely.

- Visit <http://tplinkwifi.net>, and log in with the password you set for the router.
- Go to [Advanced](#) > [Security](#) > [Service Filtering](#), and enable [Service Filtering](#).

Service Filtering

Service Filtering:

- Click [Add](#).

Filtering List

<input type="checkbox"/>	ID	Service Type	Port	IP Address	Status	Modify
--	--	--	--	--	--	--

Service Type:

 Protocol:

 Starting Port: (1-65535)

 Ending Port: (1-65535)

 Service Type:

 Filter Service For: Single IP Address IP Address Range All IP Addresses

4. Select a **Service Type** from the drop-down list and the following four fields will be automatically filled in. Select **Custom** when your desired service type is not listed, and enter the information manually.
5. Specify the IP address(es) that this filtering rule will apply to.
6. Click **Save** to make the settings effective.

■ Note: If you want to disable an entry, click the icon.

8.3. Access Control

Access Control is used to block or allow specific client devices to access your network (via wired or wireless) based on a list of blocked devices (Blacklist) or a list of allowed devices (Whitelist).

I want to: Block or allow specific client devices to access my network (via wired or wireless).

How can I do that?

1. Visit <http://tplinkwifi.net>, and log in with the password you set for the router.
2. Go to **Advanced > Security > Access Control** and enable **Access Control**.

Access Control

Access Control:

3. Select the access mode to either block (recommended) or allow the device(s) to access your network.

To block specific device(s):

- 1) Select **Blacklist** and click **Save**.

Access Mode

Access Mode:

Blacklist

Whitelist

[Save](#)

- 2) Select the device(s) to be blocked in the **Online Devices** table (or click the **Add** under the **Devices in Blacklist** and enter the **Device Name** and **MAC Address** manually).

- 3) Click **Block** above the **Online Devices** table. The selected devices will be added to **Devices in Blacklist** automatically.

Devices in Blacklist

[+](#) Add [-](#) Delete

<input type="checkbox"/>	ID	Device Name	MAC Address	Modify
--	--	--	--	--

Online Devices

[↻](#) Refresh [🔒](#) Block

<input type="checkbox"/>	ID	Device Name	IP Address	MAC Address	Connection Type
<input type="checkbox"/>	1	DESKTOP-XXXXXX	192.168.0.100	9C:8C:4B:1D:83:4B	Wired

To allow specific device(s):

- 1) Select **Whitelist** and click **Save**.

Access Mode

Access Mode:

Blacklist

Whitelist

[Save](#)

- 2) Click **Add** in the **Devices in Whitelist** section.

The screenshot shows a web interface titled "Devices in Whitelist". At the top right, there are two buttons: a green "+ Add" button and a red "- Delete" button. Below this is a table with the following columns: a checkbox, "ID", "Device Name", "MAC Address", and "Modify". The table currently contains one row with dashes in all cells. Below the table, there are two input fields: "Device Name:" followed by a text box, and "MAC Address:" followed by a text box with a dashed line pattern. At the bottom right, there are two buttons: a teal "Cancel" button and a teal "Save" button.

- 3) Enter the [Device Name](#) and [MAC Address](#). (You can copy and paste the information from [Online Devices](#) table if the device is connected to your network.)
- 4) Click [Save](#).

Done!

Now you can block or allow specific client devices to access your network (via wired or wireless) by [Blacklist](#) or [Whitelist](#).

8.4. IP & MAC Binding

IP & MAC Binding, namely, ARP (Address Resolution Protocol) Binding, is used to bind a network device's IP address to its MAC address. This will prevent ARP spoofing and other ARP attacks by denying network access to a device with a matching IP address in the Binding list, but an unrecognized MAC address.

I want to:

Prevent ARP spoofing and ARP attacks.

How can I do that?

1. Visit <http://tplinkwifi.net>, and log in with the password you set for the router.
2. Go to [Advanced](#) > [Security](#) > [IP & MAC Binding](#), and enable [IP & MAC Binding](#).

IP & MAC Binding

IP & MAC Binding:

Binding List

+ Add - Delete

<input type="checkbox"/>	ID	MAC Address	IP Address	Status	Enable	Modify
<input type="checkbox"/>	--	--	--	--	--	--

ARP List

Refresh Bind

<input type="checkbox"/>	ID	MAC Address	IP Address	Bound	Modify
<input type="checkbox"/>	1	84-16-F9-03-E2-D3	192.168.0.100	Unloaded	

3. Bind your device(s) according to your needs.

To bind the connected device(s):

- 1) Select the device(s) to be bound in the [ARP List](#).
- 2) Click [Bind](#) to add to the [Binding List](#).

To bind the unconnected device:

- 1) Click [Add](#) in the [Binding List](#) section.

Binding List

+ Add - Delete

<input type="checkbox"/>	ID	MAC Address	IP Address	Status	Enable	Modify
<input type="checkbox"/>	--	--	--	--	--	--

MAC Address:

IP Address:

Enable This Entry

- 2) Enter the [MAC address](#) and [IP address](#) that you want to bind.
- 3) Select the [Enable This Entry](#) check box to enable the entry and click [Save](#).

Done!

Enjoy the internet without worrying about ARP spoofing and ARP attacks.

Chapter 9

NAT Forwarding

Router's NAT (Network Address Translation) feature makes the devices in the LAN use the same public IP address to communicate in the internet, which protects the local network by hiding IP addresses of the devices. However, it also brings about the problem that external host cannot initiatively communicate with the specified device in the local network.

The router can use a forwarding feature to remove the isolation of NAT and allow external internet hosts to initiatively communicate with the devices in the local network, thus enabling some special features.

TP-Link router includes four forwarding rules. If two or more rules are set, the priority of implementation from high to low is Virtual Servers, Port Triggering, UPnP and DMZ.

This chapter contains the following sections:

- [Translate Address and Port by ALG](#)
- [Share Local Resources over the Internet by Virtual Server](#)
- [Open Ports Dynamically by Port Triggering](#)
- [Make Applications Free from Port Restriction by DMZ](#)
- [Make Xbox Online Games Run Smoothly by UPnP](#)

9. 1. Translate Address and Port by ALG

ALG (Application Layer Gateway) allows customized NAT (Network Address Translation) traversal filters to be plugged into the gateway to support address and port translation for certain application layer “control/data” protocols: FTP, TFTP etc. Enabling ALG is recommended.

Visit <http://tplinkwifi.net>, and log in with the password you set for the router. Go to **Advanced > NAT Forwarding > ALG**.

ALG	
PPTP Pass-through:	<input checked="" type="checkbox"/> Enable
L2TP Pass-through:	<input checked="" type="checkbox"/> Enable
IPSec Pass-through:	<input checked="" type="checkbox"/> Enable
FTP ALG:	<input checked="" type="checkbox"/> Enable
TFTP ALG:	<input checked="" type="checkbox"/> Enable
RTSP ALG:	<input checked="" type="checkbox"/> Enable
H323 ALG:	<input checked="" type="checkbox"/> Enable
SIP ALG:	<input checked="" type="checkbox"/> Enable

Save

- **PPTP Pass-through:** If enabled, it allows Point-to-Point sessions to be tunneled through an IP network and passed through the router.
- **L2TP Pass-through:** If enabled, it allows Layer 2 Point-to-Point sessions to be tunneled through an IP network and passed through the router.
- **IPSec Pass-through:** If enabled, it allows IPSec (Internet Protocol Security) to be tunneled through an IP network and passed through the router. IPSec uses cryptographic security services to ensure private and secure communications over IP networks.
- **FTP ALG:** If enabled, it allows FTP (File Transfer Protocol) clients and servers to transfer data via NAT.
- **TFTP ALG:** If enabled, it allows TFTP (Trivial File Transfer Protocol) clients and servers to transfer data via NAT.
- **RTSP ALG:** If selected, it allows media player clients to communicate with streaming media servers via NAT.
- **H323 ALG:** If enabled, it allows Microsoft NetMeeting clients to communicate via NAT.
- **SIP ALG:** If enabled, it allows clients communicate with SIP (Session Initiation Protocol) servers via NAT.

9.2. Share Local Resources over the Internet by Virtual Server

When you build up a server in the local network and want to share it on the internet, Virtual Server can realize the service and provide it to the internet users. At the same time virtual server can keep the local network safe as other services are still invisible from the internet.

Virtual server can be used for setting up public services in your local network, such as HTTP, FTP, DNS, POP3/SMTP and Telnet. Different service uses different service port. Port 80 is used in HTTP service, port 21 in FTP service, port 25 in SMTP service and port 110 in POP3 service. Please verify the service port number before configuration.

I want to: Share my personal website I've built in a local network with my friends through the internet.

For example, the personal website has been built on my home PC (192.168.0.100). I hope that my friends can visit my website. The PC is connected to the router with the WAN IP address 218.18.232.154.

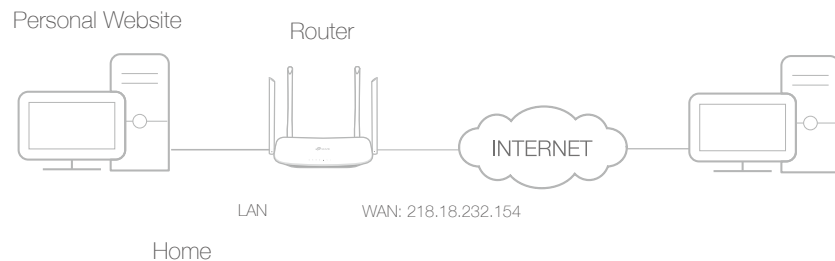

How can I do that?

1. Assign a static IP address to your PC, for example 192.168.0.100.
2. Visit <http://tplinkwifi.net>, and log in with the password you set for the router.
3. Go to **Advanced > NAT Forwarding > Virtual Servers**, click **Add**.

Virtual Servers

+ Add - Delete

ID	Service Type	External Port	Internal IP	Internal Port	Protocol	Status	Modify
-	-	-	-	-	-	-	-

Note: Virtual Server can be configured only when there is an available interface. If the external port is already used for Remote Management or CWMP, Virtual Server will not take effect.

Interface Name: ipoe_eth_0_2_d

Service Type: HTTP Scan

External Port: 80 (XX-XX or XX)

Internal IP: 192 . 168 . 0 . 100

Internal Port: 80 (XX or Blank, 1-65535)

Protocol: TCP

Enable This Entry

Cancel Save

- Click **Scan**, and select **HTTP**. The external port, internal port and protocol will be automatically filled in. Enter the PC's IP address 192.168.0.100 in the **Internal IP** field.
- Click **Save** to make the settings effective.

Tips:

- It is recommended to keep the default settings of **Internal Port** and **Protocol** if you are not clear about which port and protocol to use.
- If the service you want to use is not in the **Service Type**, you can enter the corresponding parameters manually. You should verify the port number that the service needs.
- You can add multiple virtual server rules if you want to provide several services from a router. Please note that the **External Port** cannot be overlapped.

Done!

Internet users can enter <http://WAN IP> (in this example: <http://218.18.232.154>) to visit your personal website.

Tips:

- For a WAN IP that is assigned dynamically by ISP, it is recommended to apply and register a domain name for the WAN by DDNS, go to [Set Up a Dynamic DNS Service Account](#) for more information. Then you can use <http://domain name> to visit the website.
- If you have changed the default **External Port**, you should use <http://WAN IP: External Port> or <http://domain name: External Port> to visit the website.

9.3. Open Ports Dynamically by Port Triggering

Port triggering can specify a triggering port and its corresponding external ports. When a host in the local network initiates a connection to the triggering port, all the external ports will be opened for subsequent connections. The router can record the IP

address of the host. When the data from the internet returns to the external ports, the router can forward them to the corresponding host. Port triggering is mainly applied to online games, VoIPs and video players. Common applications include MSN Gaming Zone, Dialpad, Quick Time 4 players, and so on.

Follow the steps below to configure the port triggering rules:

1. Visit <http://tplinkwifi.net>, and log in with the password you set for the router.
2. Go to [Advanced](#) > [NAT Forwarding](#) > [Port Triggering](#), and click [Add](#).

Port Triggering

+ Add - Delete

<input type="checkbox"/>	ID	Application	Triggering Port	Triggering Protocol	External Port	External Protocol	Status	Modify
-	-	-	-	-	-	-	-	-

Interface Name: ipoe_eth_0_2_d

Application: MSN Gaming Zone Scan

Triggering Port: 47624 (XX, 1-65535)

Triggering Protocol: ALL

External Port: 2300-2400,28800-29000 (XX or XX-XX, 1-65535, at most 5 pairs)

External Protocol: ALL

Enable This Entry

Cancel Save

3. Click [Scan](#), and select the desired application. The triggering port and protocol, the external port and protocol will be automatically filled in. Here we take [MSN Gaming Zone](#) as an example.
4. Click [Save](#) to make the settings effective.

Tips:

1. You can add multiple port triggering rules according to your network needs.
2. If the application you need is not listed in the [Existing Applications](#) list, you can enter the parameters manually. You should verify the external ports the application uses first and enter them into [External Port](#) field according to the format suggested.

9.4. Make Applications Free from Port Restriction by DMZ

When a PC is set to be a DMZ (Demilitarized Zone) host in the local network, it is totally exposed to the internet, which can realize the unlimited bidirectional communication between internal hosts and external hosts. The DMZ host becomes a virtual server with all ports opened. When you are not clear about which ports to open in some special

applications, like IP camera and database software, you can set the PC to be a DMZ host.

Note:

DMZ is most applicable when you don't know which ports to open. When it is enabled, the DMZ host is totally exposed to the internet, which may bring some potential safety hazards. If DMZ is not in use, please disable it in time.

I want to: Make the home PC join the internet online game without port restriction.

For example, due to some port restriction, when playing the online games, you can log in normally but cannot join a team with other players. To solve this problem, set your PC as a DMZ with all ports opened.

How can I do that?

1. Assign a static IP address to your PC, for example 192.168.0.100.
2. Visit <http://tplinkwifi.net>, and log in with the password you set for your router.
3. Go to **Advanced > NAT Forwarding > DMZ** and select the **Enable** check box to enable DMZ.



4. Enter the IP address 192.168.0.100 in the **DMZ Host IP Address** field.
5. Click **Save** to save the settings.

Done!

The configuration is completed. You've set your PC to a DMZ host and now you can join a team to game with other players.

9.5. Make Xbox Online Games Run Smoothly by UPnP

UPnP (Universal Plug and Play) protocol allows the applications or host devices to automatically find the front-end NAT device and send request to it to open the corresponding ports. With UPnP enabled, the applications or host devices in the both sides of NAT device can freely communicate with each other realizing the seamless connection of the network. You need to enable the UPnP if you want to use applications

such as multiplayer gaming, peer-to-peer connections, real-time communication (for example, VoIP or telephone conference), or remote assistance.

 **Tips:**

1. Only the application supporting UPnP protocol can use this feature.
2. UPnP feature needs the support of operating system (e.g. Windows Vista/ Windows 7/ Windows 8, etc. Some operating systems need to install the UPnP components).

For example, when you connect your Xbox to the router which has connected to the internet to play online games, UPnP will send request to the router to open the corresponding ports allowing the following data penetrating the NAT to transmit. Therefore, you can play Xbox online games without a hitch.

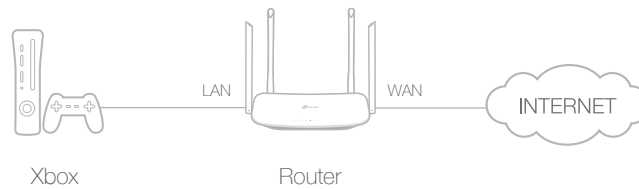

You can follow the steps to change the status of UPnP.

1. Visit <http://tplinkwifi.net>, and log in with the password you set for your router.
2. Go to **Advanced > NAT Forwarding > UPnP** and enable or disable UPnP according to your needs.

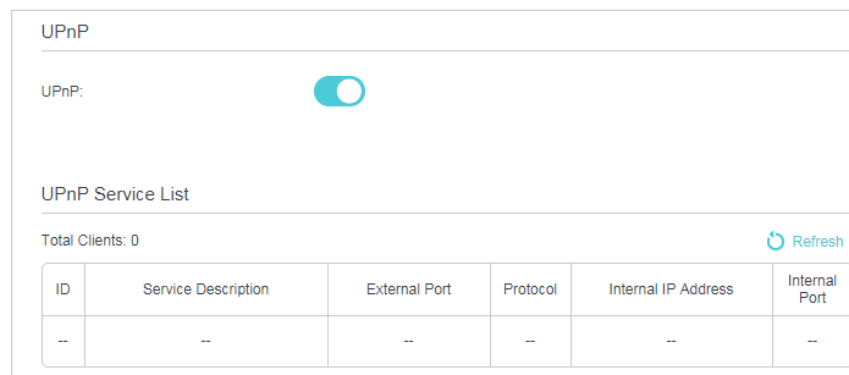

Chapter 10

VPN Server

The VPN (Virtual Private Networking) Server allows you to access your home network in a secured way through internet when you are out of home. The router offers two ways to setup VPN connection: OpenVPN and PPTP (Point to Point Tunneling Protocol) VPN.

OpenVPN is somewhat complex but with greater security and more stable. It is suitable for restricted environment, such as campus network and company intranet.

PPTP VPN is more easily used and its speed is faster, it's compatible with most operating systems and also supports mobile devices. Its security is poor and your packets may be cracked easily, and PPTP VPN connection may be prevented by some ISP.

This chapter contains the following sections, you can choose the appropriate VPN server connection type as needed.

- [Use OpenVPN to Access Your Home Network](#)
- [Use PPTP VPN to Access Your Home Network](#)

10.1. Use OpenVPN to Access Your Home Network

In the OpenVPN connection, the home network can act as a server, and the remote device can access the server through the router which acts as an OpenVPN Server gateway. To use the VPN feature, you should enable OpenVPN Server on your router, and install and run VPN client software on the remote device. Please follow the steps below to set up an OpenVPN connection.

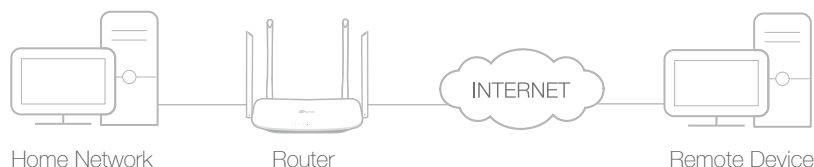

Step1. Set Up OpenVPN Server on Your Router

1. Visit <http://tplinkwifi.net>, and log in with the password you set for the router.
2. Go to **Advanced > VPN > OpenVPN**, and select **Enable VPN Server**.

OpenVPN

Note: No certificate currently, please **Generate** one before enabling VPN Server.

Enable VPN Server

Service Type: **UDP** TCP

Service Port:

VPN Subnet/Netmask:

Client Access: **Home Network Only** Internet and Home Network

Save

Note:

1. Before you enable VPN Server, we recommend you configure Dynamic DNS Service (recommended) or assign a static IP address for router's WAN port and synchronize your System Time with internet.
2. The first time you configure the OpenVPN Server, you may need to **Generate** a certificate before you enable the VPN Server.
3. Select the **Service Type** (communication protocol) for OpenVPN Server: UDP, TCP.
4. Enter a VPN **Service Port** to which a VPN device connects, and the port number should be between 1024 and 65535.
5. In the **VPN Subnet/Netmask** fields, enter the range of IP addresses that can be leased to the device by the OpenVPN server.
6. Select your **Client Access** type. Select **Home Network Only** if you only want the remote device to access your home network; select **Internet and Home Network** if you also want the remote device to access internet through the VPN Server.

7. Click [Save](#).
8. Click [Generate](#) to get a new certificate.

Certificate

Generate the certificate.

[Generate](#)

Note:

If you have already generated one, please skip this step, or click [Generate](#) to update the certificate.

9. Click [Export](#) to save the OpenVPN configuration file which will be used by the remote device to access your router.

Configuration File

Export the configuration.

[Export](#)

Step 2. Configure OpenVPN Connection on Your Remote Device

1. Visit <http://openvpn.net/index.php/download/community-downloads.html> to download the OpenVPN software, and install it on your device where you want to run the OpenVPN client utility.

Note:

You need to install the [OpenVPN](#) client utility on each device that you plan to apply the VPN function to access your router. Mobile devices should download a third-party app from Google Play or Apple App Store.

2. After the installation, copy the file exported from your router to the OpenVPN client utility's "config" folder (for example, `C:\Program Files\OpenVPN\config` on Windows). The path depends on where the OpenVPN client utility is installed.
3. Run the OpenVPN client utility and connect it to OpenVPN Server.

Tips:

You can go to [Advanced](#) > [VPN](#) > [VPN Connections](#) to view the clients that are currently connected to the OpenVPN servers.

10.2. Use PPTP VPN to Access Your Home Network

PPTP VPN Server is used to create a VPN connection for remote device. To use the VPN feature, you should enable PPTP VPN Server on your router, and configure the PPTP connection on the remote device. Please follow the steps below to set up a PPTP VPN connection.

Step 1. Set Up PPTP VPN Server on Your Router

1. Visit <http://tplinkwifi.net>, and log in with the password you set for the router.
2. Go to [Advanced](#) > [VPN Server](#) > [PPTP VPN](#), and select [Enable VPN Server](#).

PPTP VPN

Enable VPN Server

Client IP Address: -10.7.0. (up to 10 clients)

Username:

Password:

[Save](#)

Note:

Before you enable [VPN Server](#), we recommend you configure Dynamic DNS Service (recommended) or assign a static IP address for router's WAN port and synchronize your [System Time](#) with internet.

3. In the [Client IP Address](#) field, enter the range of IP addresses (up to 10) that can be leased to the devices by the PPTP VPN server.
4. Enter the [Username](#) and [Password](#) to authenticate clients to the PPTP VPN server.
5. Click [Save](#) to make the settings effective.

Step 2. Configure PPTP VPN Connection on Your Remote Device

The remote device can use the Windows built-in PPTP software or a third-party PPTP software to connect to PPTP Server. Here we use the [Windows built-in PPTP software](#) as an example.

1. Go to [Start > Control Panel > Network and Internet > Network and Sharing Center](#).
2. Select [Set up a new connection or network](#).

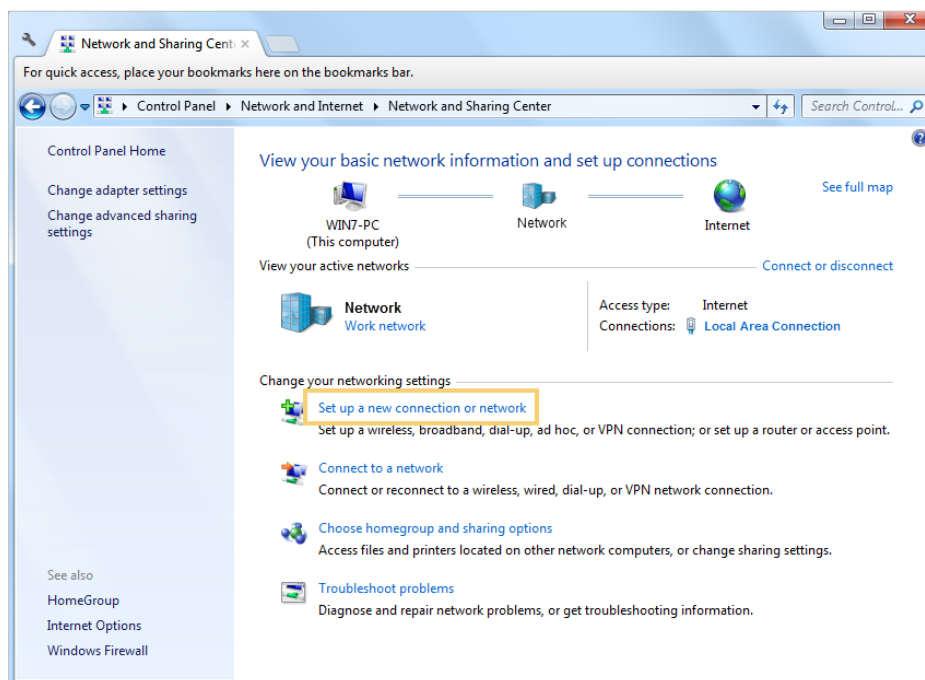

3. Select [Connect to a workplace](#) and click [Next](#).

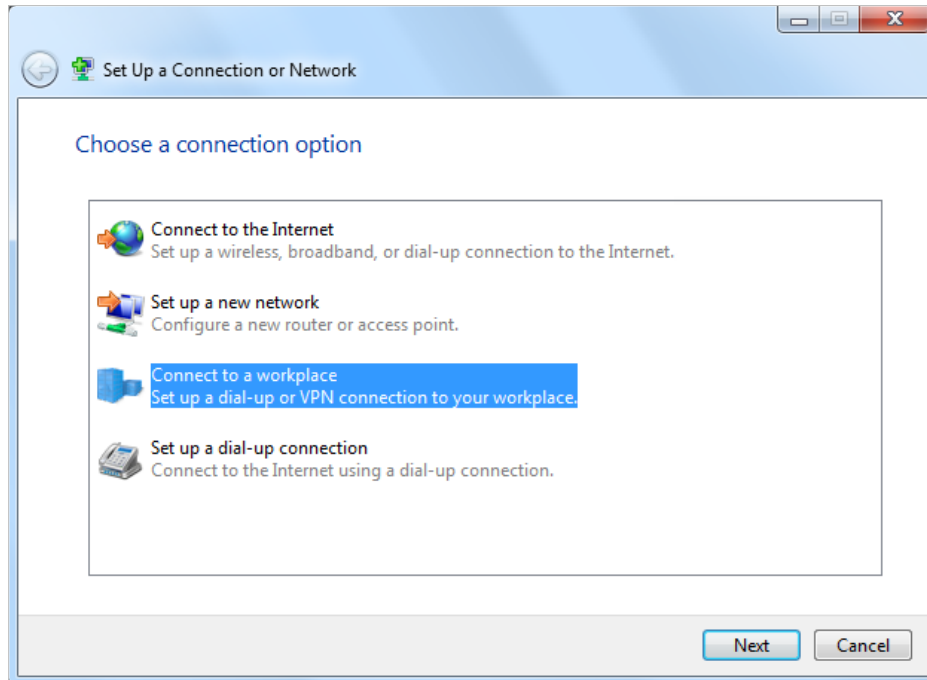

4. Select **Use my Internet connection (VPN)**.

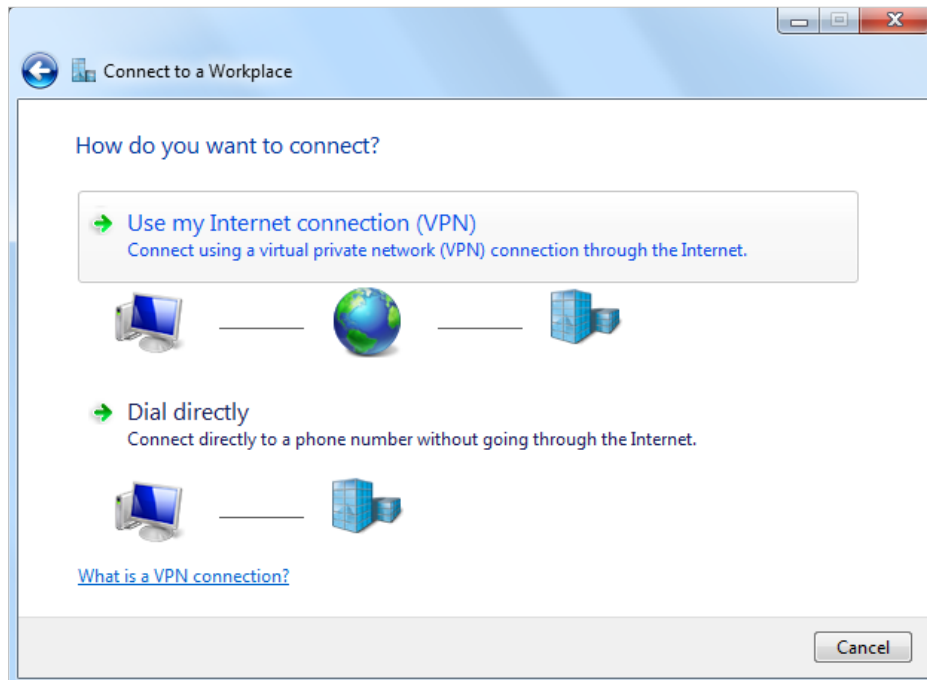

5. Enter the internet IP address of the router (for example: 218.18.1.73) in the **Internet address** field. Click **Next**.

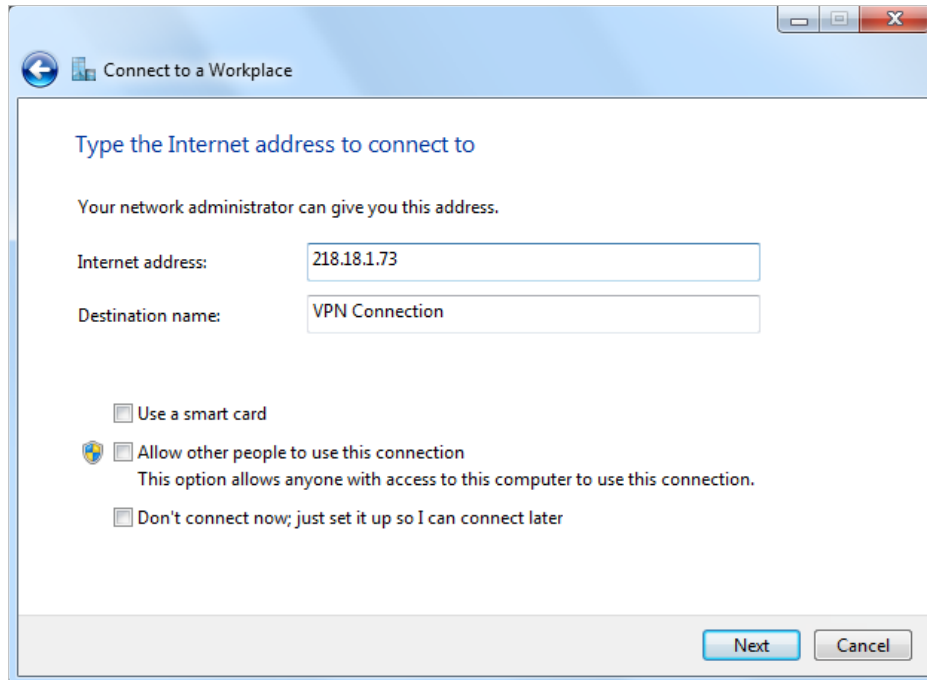

6. Enter the **User name** and **Password** you have set for the PPTP VPN server on your router, and click **Connect**.

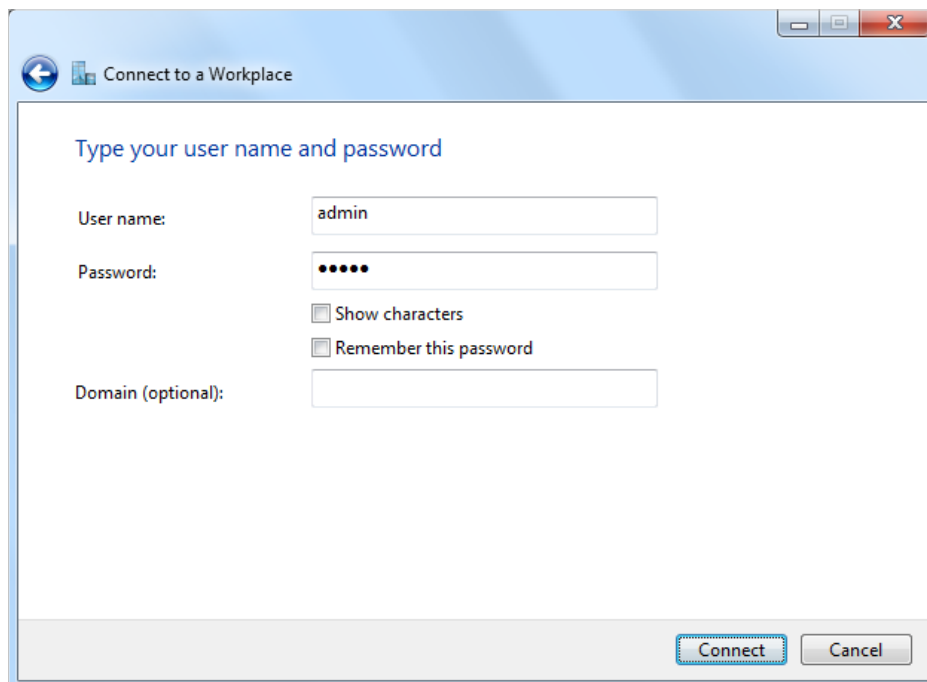

7. The PPTP VPN connection is created and ready to use.

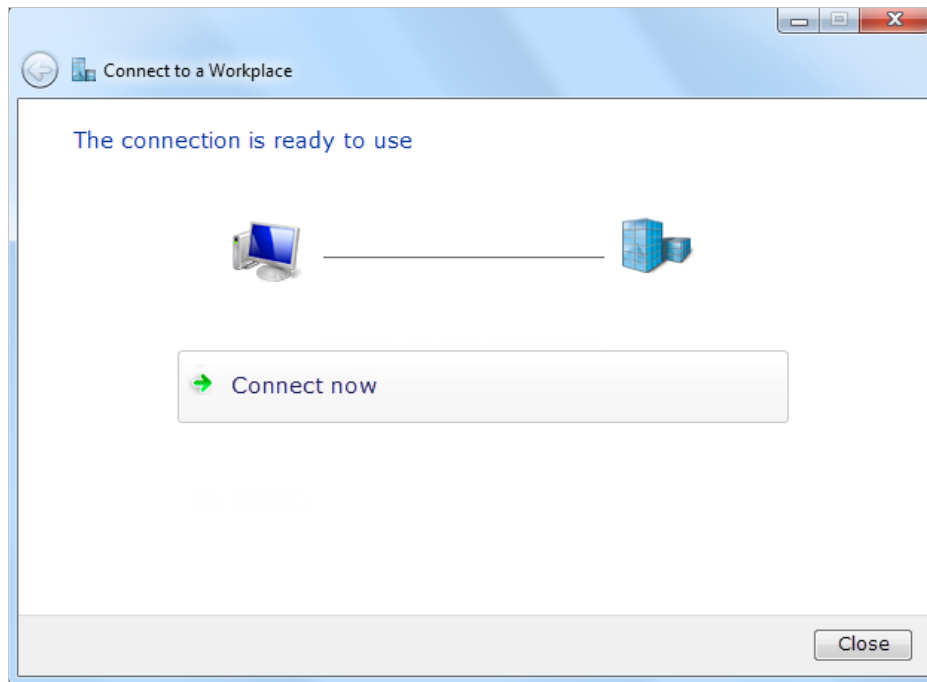

 Tips:

You can go to [Advanced](#) > [VPN](#) > [VPN Connections](#) to view the clients that are currently connected to the PPTP VPN servers.

Chapter 11

Customize Your Network Settings

This chapter introduces how to change the default settings or adjust the basic configuration of the router using the web management page.

It contains the following sections:

- [Configure LAN Settings](#)
- [Configure IPv6 LAN Settings](#)
- [Set Up a Dynamic DNS Service Account](#)
- [Create Interface Groups](#)
- [Create Static Routes](#)
- [Set Up the IPv6 Tunnel](#)
- [Specify Wireless Settings](#)
- [Schedule Your Wireless Function](#)
- [Use WPS for Wireless Connection](#)

11.1. Configure LAN Settings

11.1.1. Change the LAN IP Address

The router is preset with a default LAN IP 192.168.0.1, which you can use to log in to its web management page. The LAN IP address together with the Subnet Mask also defines the subnet that the connected devices are on. If the IP address conflicts with another device in your local network or your network requires a specific IP subnet, you can change it.

Follow the steps below to change your IP address.

1. Visit <http://tplinkwifi.net>, and log in with the password you set for the router.
2. Go to [Advanced](#) > [Network](#) > [LAN Settings](#) page and select [IPv4](#).

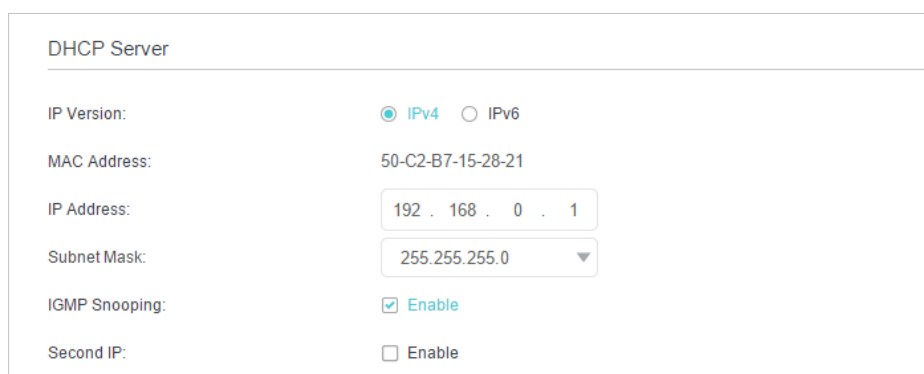

DHCP Server

IP Version: IPv4 IPv6

MAC Address: 50-C2-B7-15-28-21

IP Address: 192 . 168 . 0 . 1

Subnet Mask: 255.255.255.0

IGMP Snooping: Enable

Second IP: Enable

3. Enter a new [IP Address](#) appropriate to your needs.
4. Select the [Subnet Mask](#) from the drop-down list. The subnet mask together with the IP address identifies the local IP subnet.
5. Keep [IGMP Snooping](#) enabled by default. IGMP snooping is the process of listening to IGMP (Internet Group Management Protocol) network traffic. The function prevents hosts on a local network from receiving traffic for a multicast group they have not explicitly joined.
6. You can configure the router's [Second IP](#) and [Subnet Mask](#) for LAN interface through which you can also access the web management page.
7. Keep the rest settings as the default settings.
8. Click [Save](#) to make the settings effective.

11. 1. 2. Use the Router as a DHCP Server

You can configure the router to act as a DHCP server to assign IP addresses to its clients. To use the DHCP server function of the router, you must configure all computers on the LAN to obtain an IP Address automatically.

Follow the steps below to configure DHCP server.

1. Visit <http://tplinkwifi.net>, and log in with the password you set for the router.
2. Go to [Advanced](#) > [Network](#) > [LAN Settings](#) page and select [IPv4](#).

DHCP: Enable

DHCP Server DHCP Relay

IP Address Pool: 192 . 168 . 0 . 100 - 192 . 168 . 0 . 199

Address Lease Time: 1440 minutes. (1-2880. The default value is 1440.)

Default Gateway: 192 . 168 . 0 . 1 (Optional)

Default Domain: (Optional)

Primary DNS: 0 . 0 . 0 . 0 (Optional)

Secondary DNS: 0 . 0 . 0 . 0 (Optional)

Save

3. Enable [DHCP](#) function and select [DHCP Server](#).
4. Specify the [IP Address Pool](#), the start address and end address must be on the same subnet with LAN IP. The router will assign addresses within this specified range to its clients. It is from 192.168.0.100 to 192.168.0.199 by default.
5. Enter a time duration in the [Address Lease Time](#) field. The [Address Lease Time](#) is the amount of time in which a DHCP client can lease its current dynamic IP address assigned by the router. After the dynamic IP address expires, the user will be automatically assigned a new dynamic IP address.
6. Keep the rest settings as the default settings and click [Save](#).

Note:

1. The router can be configured to work as a [DHCP Relay](#). A DHCP relay is a computer that forwards DHCP data between computers that request IP addresses and the DHCP server that assigns the addresses. Each of the device's interfaces can be configured as a DHCP relay. If it is enabled, the DHCP requests from local PCs will be forwarded to the DHCP server that runs on WAN side.
2. You can also appoint IP addresses within a specified range to devices of the same type by using [Condition Pool](#) feature. For example, you can assign IP addresses within the range (192.168.0.50 to 192.168.0.80) to Camera devices, thus facilitating the network management. Enable DHCP feature and configure the parameters according to your situation on the [Advanced](#) > [Network](#) > [LAN Settings](#) page.

11. 1. 3. Reserve LAN IP Addresses

You can view and add a reserved address for a client. When you specify an IP address for a device on the LAN, that device will always receive the same IP address each time when it accesses the DHCP server. If there are some devices in the LAN that require permanent IP addresses, please configure Address Reservation on the router for the purpose.

Follow the steps below to reserve an IP address for your devices.

1. Visit <http://tplinkwifi.net>, and log in with the password you set for the router.
2. Go to **Advanced > Network > LAN Settings** page, and select **IPv4**.
3. Scroll down to the **Address Reservation** section, and click **Add** to add an address reservation entry for your device.

The screenshot shows the 'Address Reservation' configuration page. At the top right, there are '+ Add' and '- Delete' buttons. Below is a table with the following structure:

<input type="checkbox"/>	MAC Address	Reserved IP Address	Group	Status	Modify
--	--	--	--	--	--

Below the table, there are input fields for:

- MAC Address: [- - - - -] [Scan]
- IP Address: [. . .]
- Group: [Default]

There is a checked checkbox labeled 'Enable This Entry' and buttons for 'Cancel' and 'Save' at the bottom right.

4. Enter the **MAC Address** of the device for which you want to reserve IP address.
5. Specify the IP address which will be reserved by the router.
6. Select the **Enable This Entry** check box and click **Save** to make the settings effective.

11. 2. Configure IPv6 LAN Settings

Based on the IPv6 protocol, the router provides two ways to assign IPv6 LAN addresses:

- Configure the RADVD (Router Advertisement Daemon) address type
- Configure the DHCPv6 Server address type

11. 2. 1. Configure the RADVD Address Type

1. Visit <http://tplinkwifi.net>, and log in with the password you set for the router.

2. Go to [Advanced](#) > [Network](#) > [LAN Settings](#).
3. Select [IPv6](#) to configure IPv6 LAN parameters.

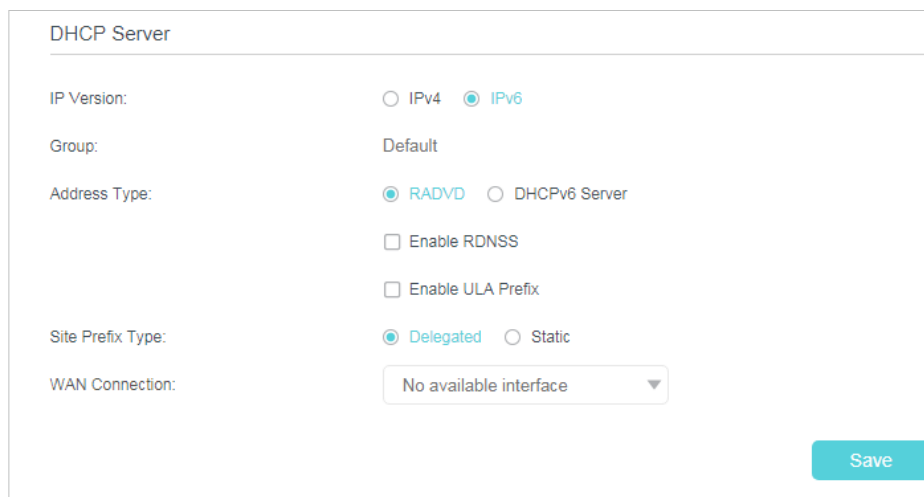

DHCP Server

IP Version: IPv4 IPv6

Group: Default

Address Type: RADVD DHCPv6 Server

Enable RDNSS

Enable ULA Prefix

Site Prefix Type: Delegated Static

WAN Connection:

Save

- 1) Select [RADVD](#) as the address type to make the router assign IPv6 address prefixes to hosts.

Note:

Do not select the [Enable RDNSS](#) and [Enable ULA Prefix](#) check boxes unless required by your ISP. Otherwise you may not be able to access the IPv6 network. For more information about RDNSS and ULA Prefix, contact our technical support.

- 2) Keep [Site Prefix Type](#) as the default setting [Delegated](#). If your ISP has provided a specific IPv6 site prefix, select [Static](#) and enter the prefix.
 - 3) Keep [WAN Connection](#) as the default settings.
4. Click [Save](#) to make the settings effective.

11.2.2. Configure the DHCPv6 Server Address Type

1. Visit <http://tplinkwifi.net>, and log in with the password you set for the router.
2. Go to [Advanced](#) > [Network](#) > [LAN Settings](#).
3. Select [IPv6](#) to configure IPv6 LAN parameters.

DHCP Server

IP Version: IPv4 IPv6

Group: Default

Address Type: RADVD DHCPv6 Server

Starting IPv6 Address: :: 1 (1~FFFE)

Ending IPv6 Address: :: FFFE (1~FFFE)

Address Lease Time: 86400 seconds

Site Prefix Type: Delegated Static

WAN Connection: No available interface

Save

- 1) Select **DHCPv6 Server** as the address type to make the router assign IPv6 addresses to hosts.
 - 2) Specify the **Starting/Ending IPv6 Address** for the IPv6 suffixes. The router will generate IPv6 addresses within the specified range.
 - 3) Keep **Address Lease Time** as the default setting.
 - 4) Keep **Site Prefix Type** as the default value **Delegated**. If your ISP has provided a specific IPv6 site prefix, select **Static** and enter the prefix.
 - 5) Keep **WAN Connection** as the default setting.
4. Click **Save** to make the settings effective.

11.3. Set Up a Dynamic DNS Service Account

Most ISPs (Internet service providers) assign a dynamic IP address to the router and you can use this IP address to access your router remotely. However, the IP address can change any time and you don't know when it changes. In this case, you might need the DDNS (Dynamic Domain Name Server) feature on the router to allow you and your friends to access your router and local servers (FTP, HTTP, etc.) using domain name, in no need of checking and remembering the IP address.

■ **Note:** DDNS does not work if the ISP assigns a private WAN IP address (such as 192.168.1.x) to the router.

To set up DDNS, please follow the instructions below:

1. Visit <http://tplinkwifi.net>, and log in with the password you set for the router.
2. Go to **Advanced > Network > Dynamic DNS**.
3. Select the **Service Provider** (Dyndns or NO-IP).

- Log in with your DDNS account, select a service provider and click [Go to register ...](#) Enter the username, password and domain name of the account (such as lisa.ddns.net).

- Click [Log in](#) and [Save](#).

Tips: If you want to use a new DDNS account, please log out first, then log in with the new account.

11.4. Create Interface Groups

I want to:

Divide my devices connected to the router into different groups and disallow devices' cross-group communication.

For example, in my house, devices connected to LAN1 and LAN3 are for work, while others for entertainment. I want to isolate working devices from others while keep all devices' access to the internet.

How can I do that?

- Visit <http://tplinkwifi.net>, and log in with the password you set for the router.
- Go to [Advanced](#) > [Network](#) > [Interface Grouping](#) page to open the configuration page where some interfaces can be grouped together.

Interface Grouping			
Group	LAN Interface	WAN Interface	Delete
Default	LAN1		
	LAN2		
	LAN3		
	LAN4		
	Wi-Fi_2.4G		
	Wi-Fi_5G		

- Click **Add** to create a new group.

Add a New Group

Group Name:

Available LAN

- LAN1
- LAN2
- LAN3
- LAN4
- Wi-Fi_2.4G
- Wi-Fi_5G

Available WAN

Enable Group Isolation

- Name the group.
- Select LAN1 and LAN3 in **Available LAN**. Wireless networks, **Wi-Fi 2.4G** and **Wi-Fi 5G**, are viewed as a LAN interface respectively.
- Select the **Enable Group Isolation** check box to isolate working devices and disallow other devices from communicating with them.
- Click **Save** to make the settings effective.

Done!

Now your working devices connected to LAN1 and LAN3 are in an isolated group!

11.5. Create Static Routes

A static route is a pre-determined path that network information must travel to reach a specific host or network. Data from one point to another will always follow the same

path regardless of other considerations. Normal internet usage does not require this setting to be configured.

I want to:

Visit multiple networks and multiple servers at the same time.

For example, in a small office, my PC can surf the internet through Router A, but I also want to visit my company's network. Now I have a switch and another Router B. I connect the devices as shown in the following image so that the physical connection between my PC and my company's server is established. To surf the internet and visit my company's network at the same time, I need to configure the static routing.

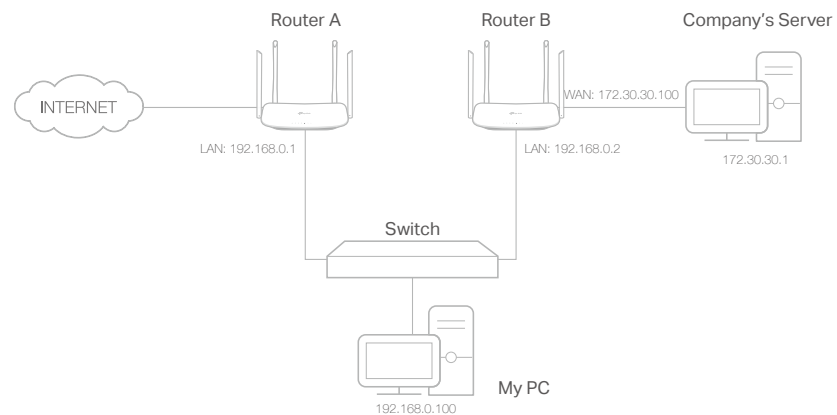

How can I do that?

1. Make sure the routers use different LAN IP addresses on the same subnet. Disable Router B's DHCP function.
2. Visit <http://tplinkwifi.net>, and log in with the password you set for the Router A.
3. Go to **Advanced > Network > Static Routing**. Select your current **WAN Interface** and click **Save**.

Default Gateway Settings IPv4 | IPv6

Select a WAN interface as the system default gateway.

Select WAN Interface: Save

Static Routing + Add - Delete

	ID	Network Destination	Subnet Mask	Gateway	Status	Modify
<input type="checkbox"/>	--	--	--	--	--	--

4. Click **Add** to add a new static routing entry. Finish the settings according to the following explanations:

Static Routing

<input type="checkbox"/>	ID	Network Destination	Subnet Mask	Gateway	Status	Modify
-	-	-	-	-	-	-

Network Destination: 172 . 30 . 30 . 1
 Subnet Mask: 255 . 255 . 255 . 255
 Gateway: 192 . 168 . 0 . 2
 Interface: LAN

Enable This Entry

Cancel Save

- **Network Destination:** The destination IP address that you want to assign to a static route. This IP address cannot be on the same subnet with the WAN IP or LAN IP of the Router A. In the example, the IP address of the company network is the destination IP address, so here we enter 172.30.30.1.
 - **Subnet Mask:** Determines the destination network with the destination IP address. If the destination is a single IP address, enter 255.255.255.255; otherwise, enter the subnet mask of the corresponding network IP. In the example, the destination network is a single IP, so here we enter 255.255.255.255.
 - **Gateway:** The IP address of the gateway device to which the data packets will be sent. This IP address must be on the same subnet with the router's IP which sends out the data. In the example, the data packets will be sent to the LAN port of Router B and then to the Server, so the default gateway should be 192.168.0.2.
 - **Interface:** Determined by the port (WAN/LAN) that sends out the data packets. In the example, the data is sent to the gateway through the LAN port of Router A, so LAN should be selected.
5. Select the **Enable This Entry** check box to enable this entry.
 6. Click **Save** to make the settings effective.

Done!

Open a web browser on your PC. Enter the company server's IP address to visit the company network.

11.6. Set Up the IPv6 Tunnel

The IPv6 Tunnel feature helps you obtain IPv6 resources based on an IPv4 WAN connection or vice versa.

IPv6 Tunnel is a transition mechanism that enables IPv6-only hosts to reach IPv4 services or vice versa and allows isolated IPv6 hosts and networks to reach each other over IPv4-only infrastructure before IPv6 completely supplants IPv4. It is a temporary solution for networks that do not support native dual-stack, where both IPv6 and IPv4 run independently.

The router provides three tunneling mechanisms: [6to4](#), [6rd](#) and [DS-Lite](#). The methods of setting up 6rd and DS-Lite tunnel are similar.

11.6.1. Use the Public IPv6 Tunnel Service-6to4

The 6to4 tunnel is a kind of public service. If there are any 6to4 servers on your network, you can use this mechanism to access IPv6 service. If your ISP provides you with an IPv4-only connection but you want to visit IPv6 websites, you can try to set up a 6to4 tunnel.

I want to: Set up the IPv6 tunnel though my ISP doesn't provide me with the tunnel service.

How can I do that?

1. Visit <http://tplinkwifi.net>, and log in with the password you set for the router.
2. Go to [Advanced](#) > [Network](#) > [IPv6 Tunnel](#).
3. Enable [IPv6 Tunnel](#), and select [6to4](#) as the tunneling mechanism and select a WAN connection from the drop-down list, then click [Save](#).

Note:

If there is no available WAN connection to choose, make sure you have connected to the internet and the connection type is not Bridge.

Done! Now you can visit the IPv6 websites with the 6to4 tunnel.

Note:

If you still can't access IPv6 resources, it may mean that no 6to4 public server was found in your network. You can contact your ISP to sign up for IPv6 connection service.

11.6.2. Specify the 6rd Tunnel with Parameters Provided by Your ISP

I want to: Specify the 6rd tunnel with the parameters provided by my 6rd tunnel service provider.

How can I do that?

1. Visit <http://tplinkwifi.net>, and log in with the password you set for the router.
2. Go to [Advanced > Network > IPv6 Tunnel](#).
3. Enable [IPv6 Tunnel](#), and select [6rd](#) as the tunneling mechanism and select a WAN connection from the drop-down list.
4. According to the parameters provided by your ISP, choose [Auto](#) or [Manual](#). More parameters are needed if you choose [Manual](#).
5. Click [Save](#).

IPv6 Tunnel

Note: Please check the IPv6 tunnel settings each time while reconfiguring WAN connection, as WAN connection configuration may take effect on tunnel settings.

IPv6 Tunnel: [Enable](#)

Tunneling Mechanism:

WAN Connection:

Configuration Type: [Auto](#) [Manual](#)

IPv4 Mask Length:

6rd Prefix:

6rd Prefix Length:

Border Relay IPv4 Address:

[Save](#)

Note:

If there is no available WAN connection to choose, make sure you have connected to the internet and the connection type is not Bridge.

Done!

Now you can visit the IPv6 websites with the 6rd tunnel.

Tips:

The way to set up DS-Lite tunnel is similar to that of 6rd tunnel. If you are provided with an IPv6-only WAN connection and have signed up for DS-Lite tunnel service, specify the DS-Lite tunnel by referring to the steps above.

11.7. Specify Wireless Settings

11.7.1. Change Basic Wireless Settings

The router's wireless network name (SSID) and password, and security option are preset in the factory. The preset SSID and password can be found on the product label. You can customize the wireless settings according to your needs.

Visit <http://tplinkwifi.net>, and log in with the password you set for the router.

➤ **To enable or disable the wireless function:**

1. Go to [Basic](#) > [Wireless](#).
2. The wireless radio is enabled by default. If you want to disable the wireless function of the router, just clear the [Enable](#) check boxes. In this case, all the wireless settings will be invalid.

➤ **To change the wireless network name (SSID) and wireless password:**

1. Go to [Basic](#) > [Wireless](#).
2. Enter a new SSID (32 characters at most) in the [Network Name \(SSID\)](#) field and a new password in the [Password](#) field and click [Save](#). The SSID and password are case-sensitive.

■ **Note:**

If you use a wireless device to change the wireless settings, you will be disconnected after the new settings are effective. Please write down the new SSID and password for future use.

➤ **To hide SSID:**

1. Go to [Basic](#) > [Wireless](#).
2. Select [Hide SSID](#), and your SSID will not be broadcast. Your SSID won't display on your wireless devices when you scan for local wireless networks and you need to manually join the network.

➤ **To change the mode or channel:**

1. Go to [Advanced](#) > [Wireless](#) > [Wireless Settings](#).

Mode:	<input type="text" value="802.11b/g/n mixed"/>
Channel:	<input type="text" value="Auto"/>
Channel Width:	<input type="text" value="Auto"/>
Transmit Power:	<input type="radio"/> Low <input type="radio"/> Middle <input checked="" type="radio"/> High
<input type="button" value="Save"/>	

2. Select the wireless network mode or channel and click [Save](#) to make the settings effective.

Mode: Select the desired transmission mode.

- 802.11n only: Select only if all of your wireless clients are 802.11n devices.
- 802.11g/n mixed: Select if you are using both 802.11g and 802.11n wireless clients.
- 802.11b/g/n mixed: Select if you are using a mix of 802.11b, 11g, and 11n wireless clients.

Note: When 802.11n only mode is selected, only 802.11n wireless stations can connect to the router. It is strongly recommended that you select 802.11b/g/n mixed, and all of 802.11b, 802.11g, and 802.11n wireless stations can connect to the router.

Channel: Select the channel you want to use from the drop-down list. This field determines which operating frequency will be used. It is not necessary to change the wireless channel unless you notice interference problems with another nearby access point.

Channel Width: Select the channel width from the drop-down list. The default setting is [Auto](#), which can adjust the channel width for your clients automatically.

Transmit Power: Select Low, Middle, or High to specify the data transmit power. The default and recommended setting is [High](#).

➤ **To change the security option:**

1. Go to [Advanced](#) > [Wireless](#) > [Wireless Settings](#).

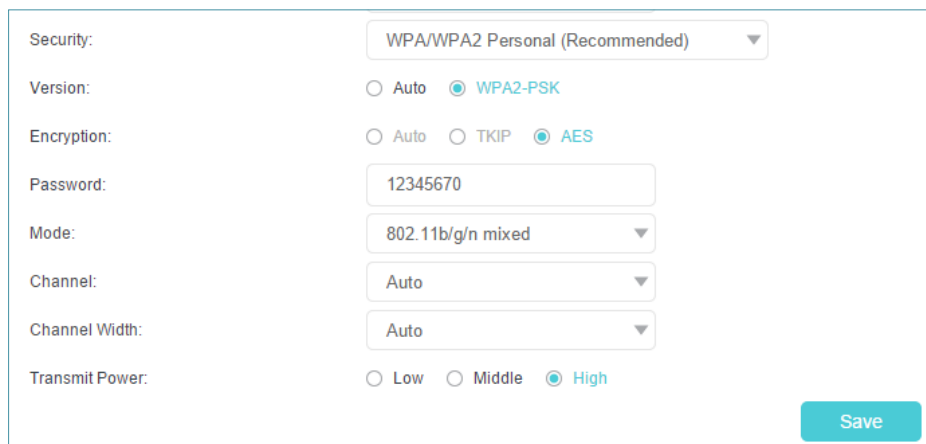

The screenshot shows the 'Wireless Settings' configuration page. The 'Security' section is expanded, showing the following options:

- Security:** WPA/WPA2 Personal (Recommended) (dropdown menu)
- Version:** Auto, WPA2-PSK
- Encryption:** Auto, TKIP, AES
- Password:** 12345670 (text input field)
- Mode:** 802.11b/g/n mixed (dropdown menu)
- Channel:** Auto (dropdown menu)
- Channel Width:** Auto (dropdown menu)
- Transmit Power:** Low, Middle, High

A blue 'Save' button is located at the bottom right of the settings panel.

2. Select an option from the [Security](#) drop-down list and configure the related parameters. The router provides four options, No Security, WPA/WPA2 Personal (Recommended), WPA/WPA2 Enterprise, WEP. WPA2 uses the newest standard and the security level is the highest. We recommend you don't change the default settings unless necessary.
3. Click [Save](#) to make the settings effective.

➤ **To enable network roaming:**

Network roaming helps devices choose better AP based on actual conditions to balance network demands.

1. Go to [Advanced](#) > [Wireless](#) > [Wireless Settings](#).
2. Locate the [Network Roaming](#) section, select the [Enable](#) check box and click [Save](#) to make the settings effective.

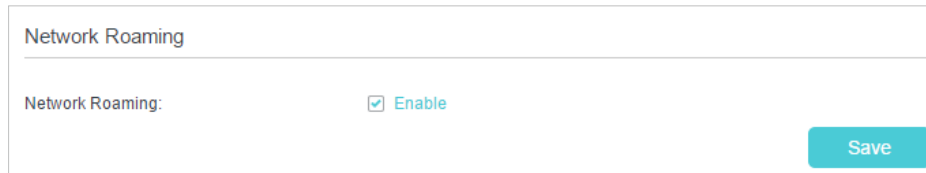

Network Roaming

Network Roaming: Enable

Save

11.7.2. Advanced Wireless Settings

Advanced wireless settings are for those who want more network controls. You can follow the instructions below to configure your router.

1. Visit <http://tplinkwifi.net>, and log in with the password you set for your router.
2. Go to [Advanced](#) > [Wireless](#) > [Advanced Settings](#) page.

➤ **To change basic advanced settings:**

Locate the [Advanced Settings](#) section and configure the advanced settings according to the explanation below, and then click [Save](#).

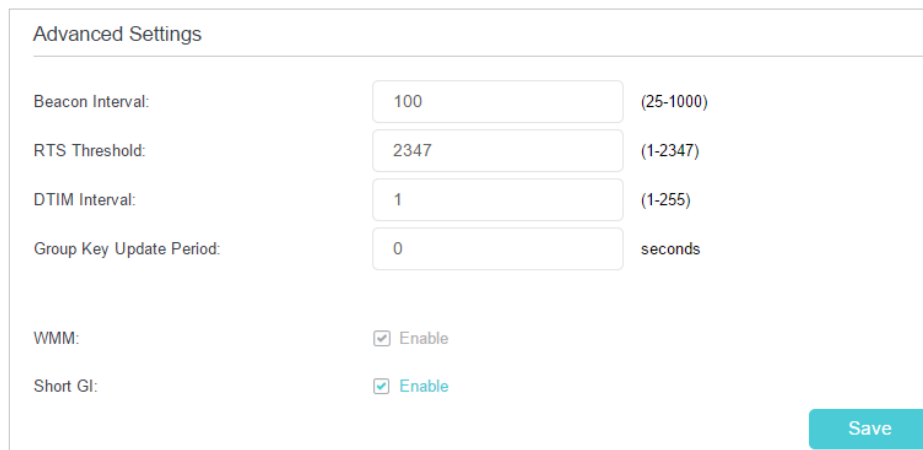

Advanced Settings

Beacon Interval: (25-1000)

RTS Threshold: (1-2347)

DTIM Interval: (1-255)

Group Key Update Period: seconds

WMM: Enable

Short GI: Enable

Save

- **Beacon Interval:** Enter a value between 25 and 1000 in milliseconds to determine the duration between which beacon packets are broadcast by the router to synchronize the wireless network. The default is 100 milliseconds.
- **RTS Threshold:** Enter a value between 1 and 2347 to determine the packet size of data transmission through the router. By default, the RTS (Request to Send) Threshold size is 2347. If the packet size is greater than the preset threshold, the router sends

Request to Send frames to a particular receiving station and negotiates the sending of a data frame, or else the packet will be sent immediately.

- **DTIM Interval:** Enter a value between 1 and 255 to determine the interval of the Delivery Traffic Indication Message (DTIM). 1 indicates the DTIM Interval is the same as [Beacon Interval](#).
- **Group Key Update Period:** Enter the number of seconds to control the time interval for the encryption key automatic renewal. The default is 0, indicating no key renewal.
- **WMM:** This feature guarantees the packets with high-priority messages being transmitted preferentially. WMM is enabled compulsively under 802.11n or 802.11ac mode.
- **Short GI:** This feature is enabled by default and recommended to increase the data capacity by reducing the Guard Interval (GI) time.

Note:

If you are not familiar with the settings mentioned above, it's strongly recommended that you keep the provided default settings; otherwise it may result in lower wireless network performance.

➤ **To enable WDS bridging function:**

Locate the [WDS](#) section and select the [Enable WDS Bridging](#) check box. And then set the information of the router to be bridged. Refer to [FAQ](#) for detailed instructions.

➤ **To enable or disable WPS function:**

WPS (Wi-Fi Protected Setup) provides you with an easier approach to set up a security-protected Wi-Fi connection. This function is enabled by default, but if you do not need this function, clear the WPS [Enable](#) check box and then click [Save](#).

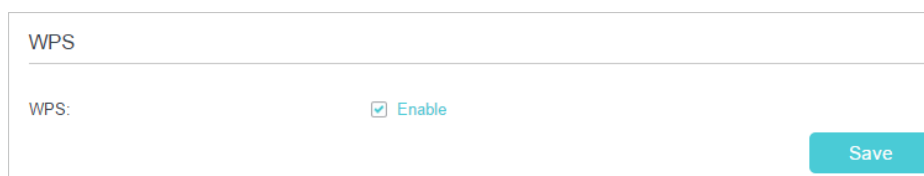

The screenshot shows a configuration window for WPS. At the top, the word 'WPS' is displayed. Below it, there is a horizontal line. Underneath the line, the text 'WPS:' is followed by a checked checkbox and the word 'Enable'. In the bottom right corner of the window, there is a blue button labeled 'Save'.

➤ **To create multi-SSID network:**

The router supports additional up to three multi-SSID wireless networks for client access in each wireless band. You can specify the access and security settings to ensure network security and privacy according to your situation.

- 1) Locate the [Multi-SSID](#) section, and click [2.4GHz](#) or [5GHz](#) to open the corresponding setup page.
- 2) Select the [Enable SSID 1 \(2 or 3\)](#) check box(es) to enable the corresponding multi-SSID network.

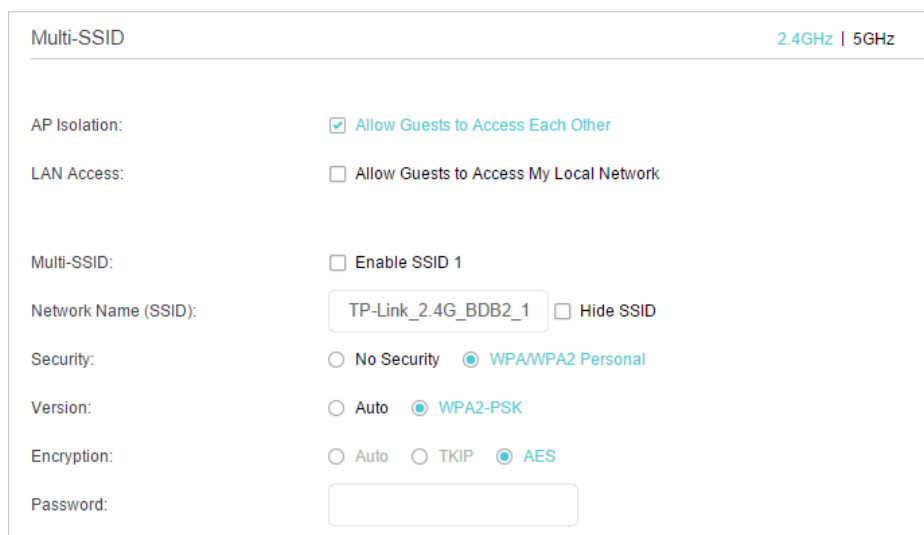

- 3) Enter a new **Network Name (SSID)** or use the default name, this field is case sensitive. Don't select **Hide SSID** unless you want your guests to manually input the SSID for Wi-Fi access.
- 4) Select the **Security** option for the multi-SSID network, **WPA/WPA2 Personal** is recommended, and you can set a password for the network.

If you want to allow the wireless devices on the multi-SSID network to communicate with each other via methods such as network neighbors, Samba, Ping, and FTP, select the **Allow Guests to Access Each Other** check box.

If you want to allow the wireless devices on the multi-SSID network to communicate with the devices connected to the router's LAN ports or main network via methods such as network neighbors, Samba, Ping, and FTP, select the **Allow Guests to Access My Local Network** check box.

- 5) Repeat step 1) to step 4) to set other wireless networks if needed, and click **Save** to make the settings effective.

11.7.3. View Wireless Information

➤ **To view the detailed wireless network settings:**

1. Visit <http://tplinkwifi.net>, and log in with the password you set for the router.
2. Go to **Advanced > Status** page. You will find the **Wireless** panel.
3. Click **2.4GHz** or **5GHz** to view the wireless details.

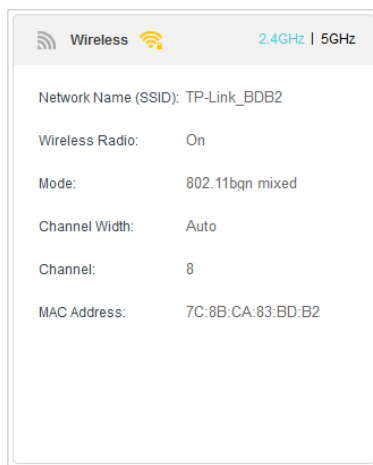

🔗 **Tips:** You can also see the wireless details by clicking the router icon on [Basic > Network Map](#).

➤ **To view the detailed information of the connected wireless clients:**

1. Visit <http://tplinkwifi.net>, and log in with the password you set for the router.
2. Go to [Advanced > Wireless > Statistics](#) page.
3. You can view the detailed information of the wireless clients, including its connection type and security option as well as the packets transmitted.

🔗 **Tips:** You can also see the wireless details by clicking the wireless clients icon on [Basic > Network Map](#).

11.8. Schedule Your Wireless Function

You can automatically turn off your wireless networks when you do not need the wireless connection.

1. Visit <http://tplinkwifi.net>, and log in with the password you set for the router.
2. Go to [Advanced > Wireless > Wireless Schedule](#).
3. Enable the [Wireless Schedule](#) function.

Wireless Schedule

Wireless Schedule:

Wireless Off Time

<input type="checkbox"/>	ID	Wireless Off Time	Repeat	Modify
--	--	--	--	--

From: 22:00

To: 00:00

Repeat: Every Day Selected Day

Selected Day: Sun Mon Tue Wed Thu Fri Sat

Cancel Save

- Click **Add** to set the **Wireless Off Time**, and click **Save** to make the settings effective.

Note:

- Make sure that the time of the router is correct before using this function. For details, refer to [Set System Time](#).
- The wireless LED will turn off if the corresponding wireless network is disabled.
- The wireless network will be automatically turned on after the time period you set.

11.9. Use WPS for Wireless Connection

You can use WPS (Wi-Fi Protected Setup) to add a new wireless device to your existing network quickly and easily.

Method 1: Use the WPS button

Use this method if your client device has a WPS button.

- Press the WiFi/WPS button of the router.
- Press the WPS button of the client device directly.
- The WPS LED flashes for about 2 minutes during the WPS process.
- When the WPS LED is on, the client device has successfully connected to the router.

Method 2: Use the WPS button on the web management page

Use this method if your client device has a WPS button.

- Visit <http://tplinkwifi.net>, and log in with the password you set for the router.
- Go to **Advanced > Wireless > WPS** page.



3. Click [Start WPS](#) on the page.
4. Press the WPS button of the client device directly.
5. The WPS LED of the router flashes for about 2 minutes during the WPS process.
6. When the WPS LED is on, the client device has successfully connected to the router.

Method 3: Enter the router's PIN on your client device

Use this method if your client device asks for the router's PIN.

1. Visit <http://tplinkwifi.net>, and log in with the password you set for the router.
2. Go to [Advanced](#) > [Wireless](#) > [WPS](#), and click [Method Two--PIN](#).

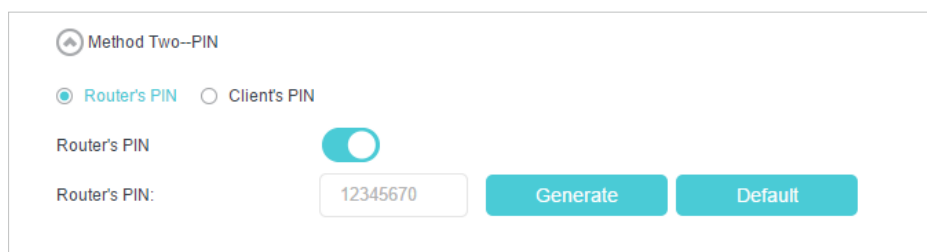

3. Take a note of the current PIN of the router. You can also click the [Generate](#) button to get a new PIN.
4. Enter the router's PIN on the client device. (The default PIN is also printed on the label of the router.)
5. The WPS LED flashes for about 2 minutes during the WPS process.
6. When the WPS LED is on, the client device has successfully connected to the router.

Note:

1. The WPS LED on the router will light on for five minutes if the device has been successfully added to the network.
2. The WPS function cannot be configured if the wireless function of the router is disabled. Please make sure the wireless function is enabled before configuring WPS.

Method 4: Enter the client device's PIN on the router

1. Visit <http://tplinkwifi.net>, and log in with the password you set for the router.
2. Go to [Advanced](#) > [Wireless](#) > [WPS](#), and click [Method Two--PIN](#).
3. Select [Client's PIN](#).

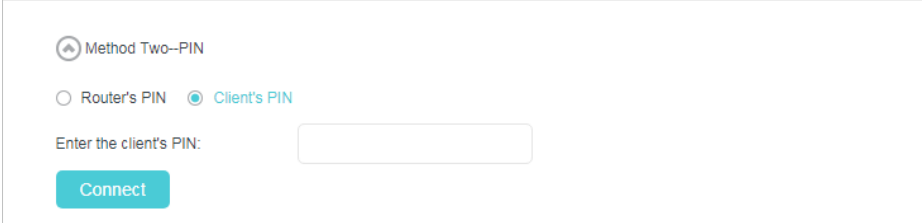

The screenshot shows a web interface for configuring a network device. At the top, there is a section titled "Method Two-PIN" with a small upward-pointing arrow icon. Below this title, there are two radio button options: "Router's PIN" and "Client's PIN". The "Client's PIN" option is selected, indicated by a blue dot. Below the radio buttons, there is a text label "Enter the client's PIN:" followed by an empty text input field. At the bottom left of the form, there is a blue button labeled "Connect".

4. Enter the client device's PIN. Then click the [Connect](#) button.
5. [Device has been added successfully!](#) or the similar information will appear on the web page, which means the client device has successfully connected to the router.

Chapter 12

Manage Your Router

This chapter introduces how to change the system settings and administrate your router's network.

This chapter contains the following sections:

- [Set System Time](#)
- [Test Internet Connectivity](#)
- [Update the Firmware](#)
- [Back Up and Restore Configuration Settings](#)
- [Reboot the Router](#)
- [Administration Management](#)
- [System Log](#)
- [CWMP Settings](#)
- [SNMP Settings](#)
- [Monitor the Internet Traffic Statistics](#)

12.1. Set System Time

System time is the time displayed while the router is running. The system time you configure here will be used for other time-based functions like Parental Controls and Wireless Schedule. You can manually set how to get the system time.

Follow the steps below to set your system time.

1. Visit <http://tplinkwifi.net>, and log in with the password you set for the router.
2. Go to [Advanced](#) > [System Tools](#) > [Time Settings](#) page.

System Time

Current Time: 01/01/2016 00:11:46

Time Zone: (GMT) Greenwich Mean Time: Dublin, Edinburgh, London, Lisbon

Date: 1/1/2016 (MM/DD/YY)

Time: 0 : 2 : 23

NTP Server I: 0.0.0.0 (Optional)

NTP Server II: 0.0.0.0 (Optional)

Get from PC Get from the Internet Save

3. Configure the system time using the following methods:
 - Manually:** Select your time zone, enter the date and select the local time.
 - Get from PC:** Click this button if you want to use the current time of your PC.
 - Get from the Internet:** Click this button if you want to get time from the internet. Make sure your router can access the internet before you select this way to get system time.
4. Click [Save](#).
5. After setting the system time, you can set [Daylight Saving Time](#) according to your needs. Enable [Daylight Saving Time](#), and set the start and end time and then click [Save](#) to make the settings effective.

Daylight Saving Time

Enable Daylight Saving Time

Start: 2016 Mar Last Sun 02:00

End: 2016 Oct Last Sun 03:00

Save

12.2. Test Internet Connectivity

Diagnostics function is used to test the connectivity between the router and the host or other network devices.

1. Visit <http://tplinkwifi.net>, and log in with the password you set for the router.
2. Go to [Advanced](#) > [System Tools](#) > [Diagnostics](#) page.

➤ **To test the internet connection of the router:**

Locate the [Diagnostic Tools](#) section, and click the [Start](#) to test the internet connectivity and you will find the test results in the gray box.

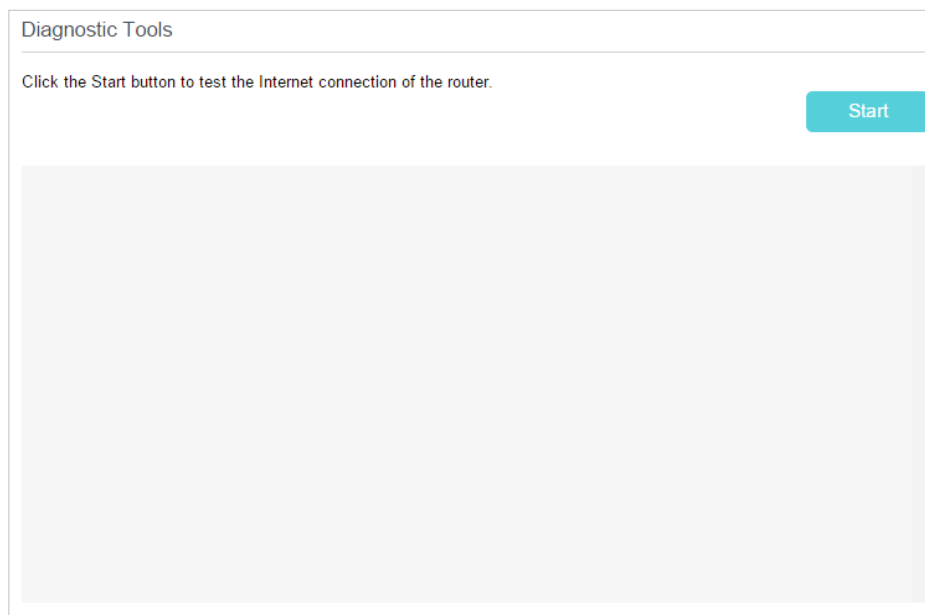

➤ **To run ping and traceroute tools:**

- 1) Locate the [Diagnostic Tools](#) section.

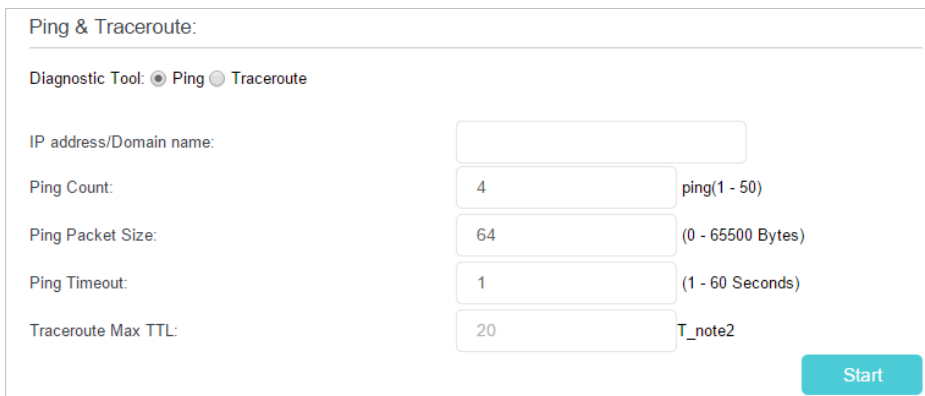

- 2) Select [Ping](#) or [Traceroute](#) as the diagnostic tool to test the connectivity.

- [Ping](#) is used to test the connectivity between the router and the tested host, and measure the round-trip time.
 - [Traceroute](#) is used to display the route (path) your router has passed to reach the tested host, and measure transit delays of packets across an internet Protocol network.
- 3) Enter the [Target IP Address/Domain Name](#) of the tested host. You can change the default test options if necessary.
 - 4) Click [Start](#) to begin the diagnostics, and you will find the test results in the gray box.

12.3. Update the Firmware

TP-Link is dedicated to improving product features, giving you a better network experience.

We will inform you through the web management page if there's any update firmware available for your router. The latest firmware can also be downloaded from the [Support](#) page of our website www.tp-link.com for free.

Note:

1. Make sure that you have a stable connection between the router and your computer. It is NOT recommended to upgrade the firmware wirelessly.
2. Back up your router configuration before upgrading the firmware.
3. DO NOT turn off the router during the firmware upgrade.

You can follow the steps below to manually update the firmware.

1. Download the latest firmware file for the router from our website www.tp-link.com.
2. Visit <http://tplinkwifi.net>, and log in with the password you set for the router.
3. Go to [Advanced](#) > [System Tools](#) > [Firmware Upgrade](#).
4. Focus on the [Device Information](#) section. Make sure the downloaded firmware file matches with the [Hardware Version](#).
5. Focus on the [Local Upgrade](#) section. Click [Browse](#) to locate the downloaded new firmware file, and click [Upgrade](#).

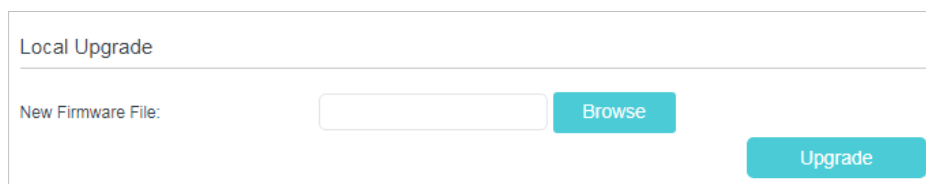

Local Upgrade

New Firmware File: [Browse](#) [Upgrade](#)

6. Wait a few minutes for the upgrading and rebooting.

12.4. Back Up and Restore Configuration Settings

The configuration settings are stored as a configuration file in the router. You can back up the configuration file to your computer for future use and restore the router to a previous settings from the backup file when needed. Moreover, if needed you can erase the current settings and reset the router to its default factory settings.

1. Visit <http://tplinkwifi.net>, and log in with the password you set for the router.
2. Go to [Advanced](#) > [System Tools](#) > [Backup & Restore](#).

➤ **To back up configuration settings:**

Click [Backup](#) to save a copy of the current settings to your local computer. A conf.bin file will be stored to your computer.

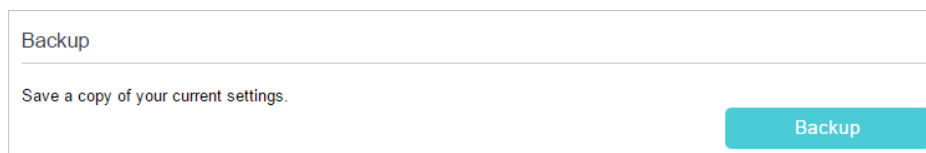

The screenshot shows a web interface titled "Backup". Below the title is a horizontal line. Underneath, the text reads "Save a copy of your current settings." To the right of this text is a teal button labeled "Backup".

➤ **To restore configuration settings:**

- 1) Click [Browse](#) to locate the previous backup configuration file, and click [Restore](#).

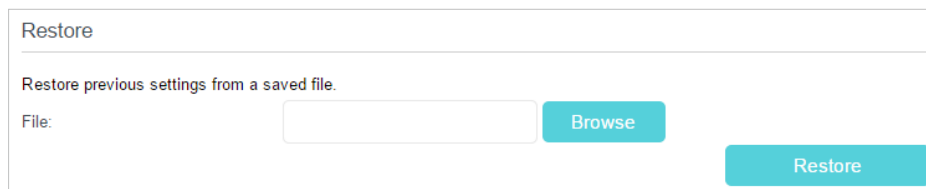

The screenshot shows a web interface titled "Restore". Below the title is a horizontal line. Underneath, the text reads "Restore previous settings from a saved file." Below this text is a "File:" label followed by a text input field and a teal button labeled "Browse". To the right of the input field and "Browse" button is another teal button labeled "Restore".

- 2) Wait a few seconds for the restoring and rebooting.

➤ **To reset the router to factory default settings:**

- 1) Locate the [Factory Default Restore](#) section, and click [Factory Restore](#) to reset the router.

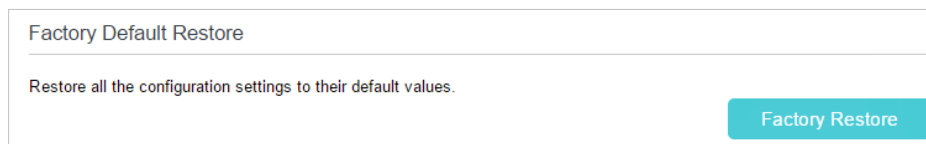

The screenshot shows a web interface titled "Factory Default Restore". Below the title is a horizontal line. Underneath, the text reads "Restore all the configuration settings to their default values." To the right of this text is a teal button labeled "Factory Restore".

- 2) Wait a few seconds for the resetting and rebooting.

📌 **Note:**

1. During the resetting process, do not turn off the router.
2. We strongly recommend you back up the current configuration settings before resetting the router.

12.5. Reboot the Router

The Reboot feature cleans the cache to enhance the running performance of the router. You can reboot the router manually or set it to reboot regularly.

1. Visit <http://tplinkwifi.net>, and log in with the password you set for the router.
2. Go to [Advanced](#) > [System Tools](#) > [Reboot](#), and you can restart your router.

➤ **To reboot the router manually:**

Click [Reboot](#), and wait a few minutes for the router to rebooting.

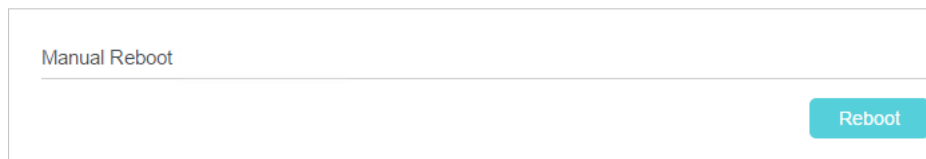

Manual Reboot

Reboot

➤ **To schedule the router to reboot at a specific time:**

- 1) Enable [Auto Reboot](#).
- 2) Specify the [Time](#) when the router reboots and the [Auto Reboot Interval](#) to decide how often it reboots.

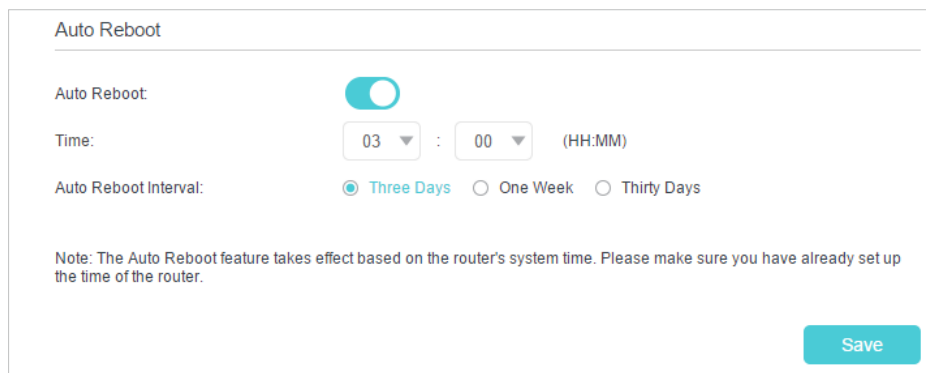

Auto Reboot

Auto Reboot

Time: 03 : 00 (HH:MM)

Auto Reboot Interval: Three Days One Week Thirty Days

Note: The Auto Reboot feature takes effect based on the router's system time. Please make sure you have already set up the time of the router.

Save

- 3) Click [Save](#) to make the settings effective.

Some settings of the router may take effect only after rebooting, including:

- Change the LAN IP Address (system will reboot automatically).
- Change the DHCP Settings.
- Change the Operation Mode.
- Change the Web Management Port.
- Upgrade the firmware of the router (system will reboot automatically).
- Restore the router to its factory defaults (system will reboot automatically).
- Update the configuration with the file (system will reboot automatically).

Note:

The Auto Reboot feature takes effect based on the router's system time. Please make sure you have already set up the time of the router.

12.6. Administration Management

12.6.1. Change the Login Password

A login password is required to log in to the router's web management page. You are asked to set a login password at first login. You can change it with the account management feature.

1. Visit <http://tplinkwifi.net>, and log in with the password you set for the router.
2. Go to **Advanced > System Tools > Administration**, and locate the **Account Management** section.

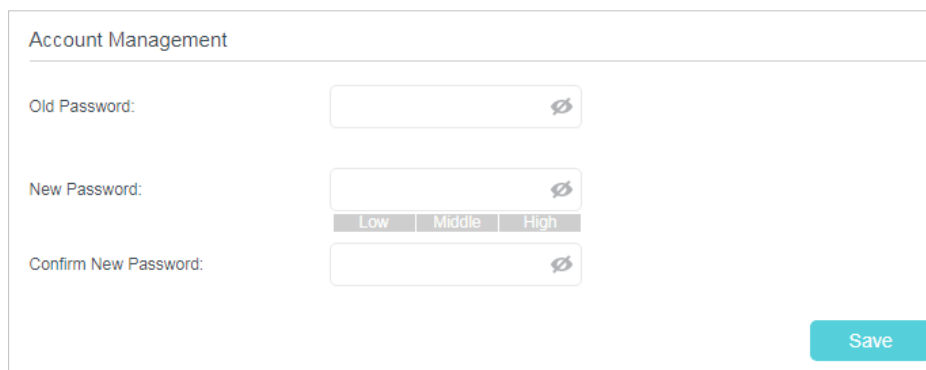

The screenshot shows the 'Account Management' section of a web interface. It contains three input fields for passwords: 'Old Password', 'New Password', and 'Confirm New Password'. Each field has a toggle icon to the right. Below the 'New Password' field, there are three radio buttons labeled 'Low', 'Middle', and 'High' for password strength selection. A blue 'Save' button is located at the bottom right of the form.

3. Enter the old password and a new password twice (both case-sensitive).
4. Click **Save** to make the settings effective.

12.6.2. Local Management

You can control the local devices' authority to manage the router via Local Management feature. By default all local connected devices are allowed to manage the router. You can also specify one device to manage the router and enable local management over a more secure way, HTTPS.

Follow the steps below to allow only the specific device to manage the router via the local management over HTTPS.

1. Visit <http://tplinkwifi.net>, and log in with the password you set for the router.
2. Go to **Advanced > System Tools > Administration**, and locate the **Local Management** section.

3. Enable **Local Management over HTTPS** and keep the **Port for HTTP** and **Port for HTTPS** as the default settings. Enter the **IP address** or **MAC address** of the local device to manage the router.

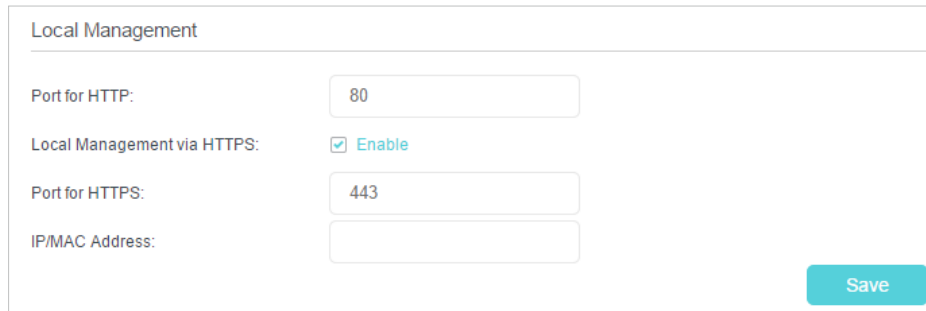

Local Management

Port for HTTP: 80

Local Management via HTTPS: Enable

Port for HTTPS: 443

IP/MAC Address:

Save

4. Click **Save**.

Now, you can manage the router over both HTTP (<http://tplinkwifi.net>) and HTTPS (<https://tplinkwifi.net>).

Note:

If you want all local devices can manage the router, just leave the **IP/MAC Address** field blank.

12.6.3. Remote Management

By default, the remote devices are not allowed to manage the router from the internet. You can enable remote management over HTTP and/or HTTPS if needed. HTTPS is a more secure way to access the router.

Note:

If your ISP assigns a private WAN IP address (such as 192.168.x.x or 10.x.x.x), you cannot use the remote management feature because private addresses are not routed on the internet.

Follow the steps below to allow remote devices to manage the router over HTTPS.

1. Visit <http://tplinkwifi.net>, and log in with the password you set for the router.
2. Go to **Advanced > System Tools > Administration**, and locate the **Remote Management** section.

3. Enable [Remote Management](#) and [Remote Management via HTTPS](#) to allow for HTTPS connection. Keep the [Port](#) as the default setting.
4. Set the client device allowed for remote management. Select [All](#) to allow all remote devices to manage the router. If you just want to allow a specific device to manage the router, select [Only the Following IP/MAC Address](#) and enter the IP/MAC address of the remote device.
5. Click [Save](#).

All devices or the specific device on the internet can log in to your router using the address displayed on the [Manage This Router via the Address](#) field to manage the router.

 **Tips:**

1. If you were warned about the certificate when visiting the web management page remotely, click [Trust](#) (or a similar option) to continue. To avoid this warning, you can download and install the certificate on the router's web management page at [Advanced > System Tools > Administration](#).

2. The router's WAN IP is usually a dynamic IP. Please refer to [Set Up a Dynamic DNS Service Account](#) if you want to log in to the router through a domain name.

12.6.4. HTTP Referer Head Check

HTTP referer header check function can protect your networks against CSRF attacks. This function is enabled by default. You can disable this function if needed.

1. Visit <http://tplinkwifi.net>, and log in with the password you set for the router.
2. Go to [Advanced > System Tools > Administration](#), and locate the [HTTP Referer Head Check](#) section.

3. Clear the **Enable** check box and click **Save** if you want to disable this function.

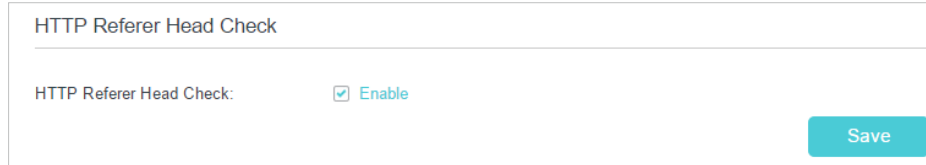

HTTP Referer Head Check

HTTP Referer Head Check: Enable

Save

12.6.5. ICMP Ping

ICMP (Internet Control Message Protocol) Ping is used to diagnose the network by sending ICMP echo request packets to the target remote or local host and waiting for an ICMP response.

You can control the router's replies to ICMP Ping requests.

1. Visit <http://tplinkwifi.net>, and log in with the password you set for the router.
2. Go to **Advanced > System Tools > Administration**, and locate the **ICMP Ping** section.

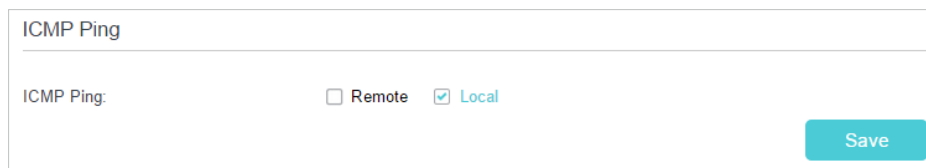

ICMP Ping

ICMP Ping: Remote Local

Save

3. Specify the ICMP Ping reply options.
 - **Remote:** Select it if you want the computers on a public network to ping the router's WAN IP address.
 - **Local:** Enabled by default, if enabled, the computers on a private network can ping the router's LAN IP address.
4. Click **Save** to make the settings effective.

12.7. System Log

System Log can help you know what happened to your router, facilitating you to locate the malfunctions. For example when your router does not work properly, you may need to save the system log and send it to the technical support for troubleshooting.

1. Visit <http://tplinkwifi.net>, and log in with the password you set for the router.
2. Go to **Advanced > System Tools > System Log** page.

System Log

Type:

Level:

[Refresh](#) [Delete All](#)

ID	Time	Type	Level	Log Content
1	2016-01-01 02:43:34	HTTPD	Notice	Clear log.

➤ **To view the system logs:**

You can view specific system logs by selecting the log type and level.

Click [Refresh](#) to refresh the log list.

➤ **To save the system logs:**

You can save the system logs to your local computer or a remote server.

Click [Save Log](#) to save the logs in a txt file to your computer.

Click [Log Settings](#) to set the storage path of logs.

Log Settings

[Save Locally](#)

Minimum Level:

[Save Remotely](#)

Minimum Level:

Server IP:

Server Port:

Local Facility Name:

- **Save Locally:** Select this option to cache the system log to the router's local memory, select the minimum level of system log to be saved from the drop-down list. The logs will be shown in the table in descending order on the System Log page.
- **Save Remotely:** Select this option to send the system log to a remote server, select the minimum level of system log to be saved from the drop-down list and enter the information of the remote server. If the remote server has a log viewer client or a sniffer tool implemented, you can view and analyze the system log remotely in real-time.

12.8. CWMP Settings

The router supports CWMP (CPE WAN Management Protocol), also called TR-069. This collects information, performs diagnostics and configures the devices automatically via ACS (Auto-Configuration Server).

1. Visit <http://tplinkwifi.net>, and log in with the password you set for the router.
2. Go to [Advanced](#) > [System Tools](#) > [CWMP Settings](#) page.

CWMP Settings

CWMP:

Inform:

Inform Interval: (seconds)

ACS URL:

ACS Username:

ACS Password:

Interface used by TR-069 client:

Display SOAP messages on serial console:

Connection Request Authentication

Username:

Password:

Path:

Port:

URL:

Simple Traversal of UDP over NATs:

- **CWMP:** Enable or disable the CWMP (CPE WAN Management Protocol) function.
- **Inform:** Enable or disable the function of sending an inform message to the ACS (Auto Configuration Server) periodically.
- **Inform Interval:** Set the time interval in seconds when the Inform message will be sent to the ACS.
- **ACS URL:** Enter the web address of the ACS which is provided by your ISP.
- **ACS Username/Password:** Enter the username/password to log in to the ACS server.
- **Interface used by TR-069 client:** Select which interface to be used by the TR-069 client.

- **Display SOAP messages on serial console:** Enable or disable this function.
- **Connection Request Authentication:** Select this check box to enable authentication for the connection request.
- **Username/Password:** Enter the username/password for the ACS server to log in to the router.
- **Path:** Enter the path for the ACS server to log in to the router.
- **Port:** Enter the port that connects to the ACS server.
- **URL:** Enter the URL that connects to the ACS server.
- **Simple Traversal of UDP over NATs:** Select this check box to enable STUN for the connection request and set the STUN maximum and minimum keep alive period, server address and port.
- **Get RPC Methods:** Click to get the methods to support CWMP.

Click **Save** to make the settings effective.

12.9. SNMP Settings

SNMP (Simple Network Management Protocol) is widely used in network management for network monitoring. It allows management applications to retrieve status updates and statistics from the SNMP agent within this device. In this way, network administrators can easily search and modify the information on any node on the network. Meanwhile, they can locate faults promptly and implement the fault diagnosis, capacity planning and report generating.

The **SNMP Agent** is an application running on the router that performs the operational role of receiving and processing SNMP messages, sending responses to the SNMP manager, and sending traps when an event occurs. So a router contains SNMP "agent" software can be monitored and/or controlled by SNMP Manager using SNMP messages.

1. Visit <http://tplinkwifi.net>, and log in with the password you set for the router.
2. Go to **Advanced > System Tools > SNMP Settings** page.

- **SNMP Agent/SNMP Agent for WAN:** Turn on to enable the built-in SNMP agent that allows the router to operate as the operational role in receiving and processing of SNMP messages, sending responses to the SNMP manager, and triggering SNMP traps when an event occurs.
- **Read-only Community:** Displays the default public community string that protects the router from unauthorized access.
- **Write Community:** Displays the default write community string that protects the router from unauthorized changes.
- **System Name:** Displays the administratively-assigned name for this managed device.
- **System Description:** Displays the textual description of the managed device. This value should include the full name and version identification of the system's hardware type, software operating-system, and networking software.
- **System Location:** Displays the physical location of this device (for example, the telephone closet, 3rd floor).
- **System Contact:** Displays the textual identification of the contact person for this managed device, together with information on how to contact this person.
- **Trap Manager IP:** Displays the IP address of the host to receive the traps.

You are suggested to keep the default settings. Click **Save** to make the settings effective.

12. 10. Monitor the Internet Traffic Statistics

The traffic statistics function allows you to monitor the volume of internet traffic statistics. You can view the network traffic of the LAN, WAN and WLAN sent and received packets.

1. Visit <http://tplinkwifi.net>, and log in with the password you set for the router.

2. Go to [Advanced](#) > [System Tools](#) > [Statistics](#).
3. Turn on [Enable Traffic Statistics](#) to enable traffic statistics function, you can view the total number of packets and bytes received and transmitted by the router within the selected [Statistics Interval](#). This function is disabled by default.

Traffic Statistics

Enable Traffic Statistics:

Statistics Interval: seconds

[Save](#)

4. You can refer to [Traffic Statistics List](#) for the detailed information about the traffic usage of all devices.

Traffic Statistics List

[Refresh](#) [Reset All](#) [Delete All](#)

IP Address/ MAC Address	Total Packets	Total Bytes	Current Packets	Current Bytes	Current ICMP Tx	Current UDP Tx	Current SYN Tx	Modify
--	--	--	--	--	--	--	--	--

FAQ

Q1. What should I do if I forget my wireless password?

The default wireless password is printed on the label of the router. If the password has been changed:

1. Connect your computer to the router using an Ethernet cable.
2. Visit <http://tplinkwifi.net>, and log in with the password you set for the router.
3. Go to [Basic](#) > [Wireless](#) to retrieve or reset your wireless password.

Q2. What should I do if I forget my web management password?

- If you are using a web browser to log in, click [Forgot password](#) on the login page and then follow the instructions to reset it.
- Alternatively, press and hold the RESET button of the router for about 5 seconds, and then visit <http://tplinkwifi.net> to create a new login password.

Note: You'll need to reconfigure the router to surf the internet once the router is reset, and please mark down your new password for future use.

Q3. What should I do if I cannot log in to the router's web management page?

This can happen for a variety of reasons. Please try the methods below to log in again.

- Make sure your computer is connected to the router correctly and the corresponding LED indicator(s) light up.
- Make sure the IP address of your computer is configured as [Obtain an IP address automatically](#) and [Obtain DNS server address automatically](#).
- Make sure <http://tplinkwifi.net> or <http://192.168.0.1> is correctly entered.
- Check your computer's settings:
 - 1) Go to [Start](#) > [Control Panel](#) > [Network and Internet](#), and click [View network status and tasks](#).
 - 2) Click [Internet Options](#) on the bottom left.
 - 3) Click [Connections](#) and select [Never dial a connection](#).

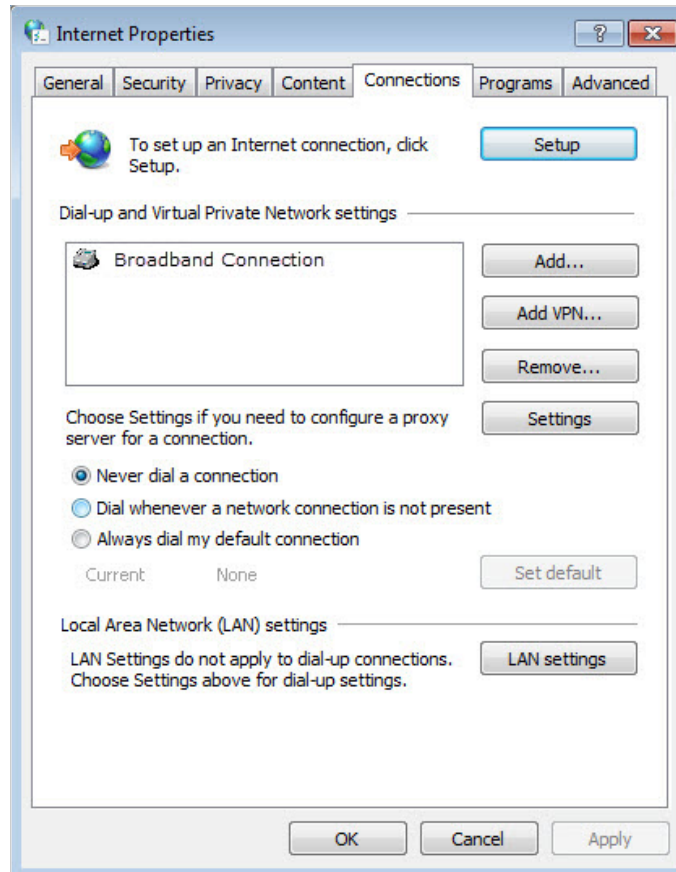

4) Click [LAN settings](#) and clear the following three options and click [OK](#).

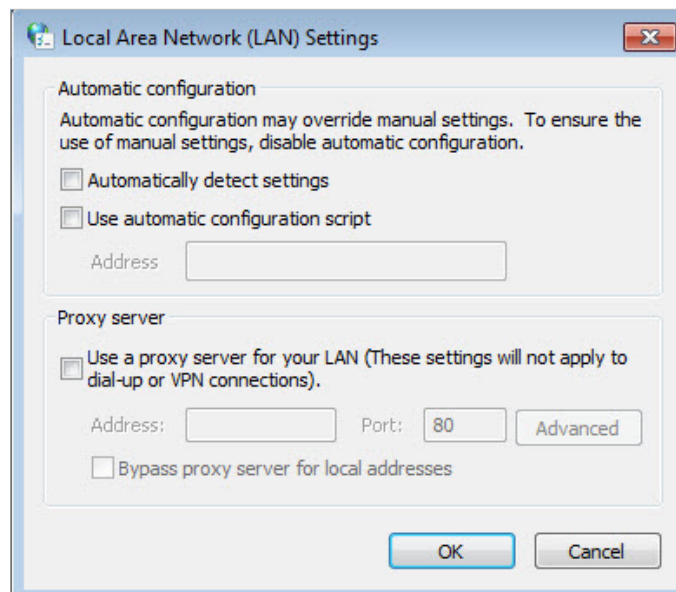

5) Go to [Advanced](#) > [Restore advanced settings](#), click [OK](#) to save the settings.

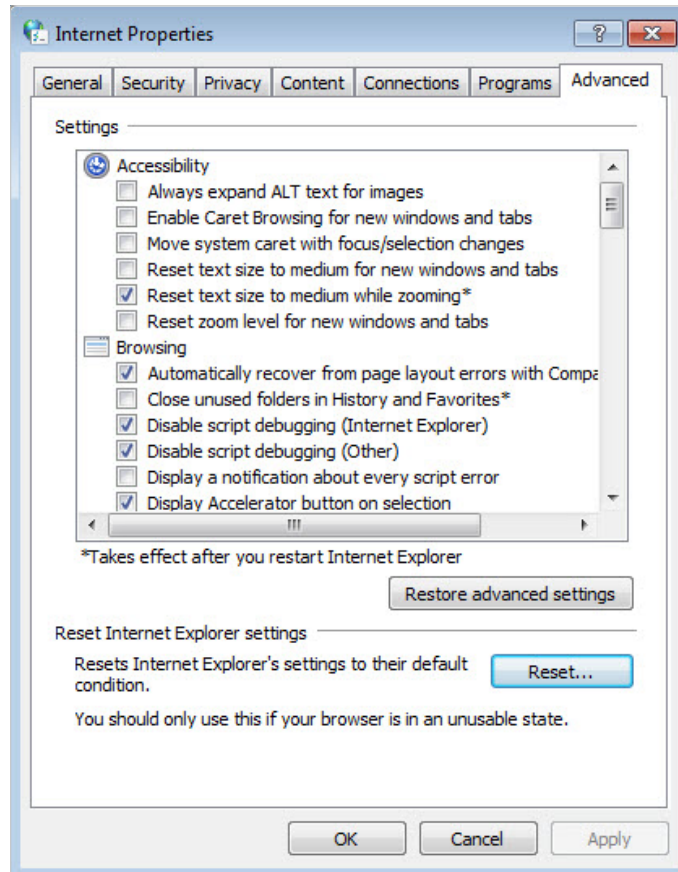

- Use another web browser or computer to log in again.
- Reset the router to factory default settings and try again. If login still fails, please contact the technical support.

■ Note: You'll need to reconfigure the router to surf the internet once the router is reset.

Q4. How do I use the WDS Bridging function to extend my wireless network?

For example, my house covers a large area. The wireless coverage of the router I'm using (the root router) is limited. I want to use an extended router to boost the wireless network of the root router.

■ Note:

1. WDS bridging only requires configuration on the extended router.
2. WDS bridging function can be enabled either in 2.4GHz frequency or 5GHz frequency for a dual-band router. We use the WDS bridging function in 2.4GHz frequency as example.

1. Visit <http://tplinkwifi.net>, and log in with the password you set for the router.

2. Configure the IP address of the router:

- 1) Go to **Advanced > Network > LAN Settings**, configure the IP address of the extended router to be in the same subnet with the root router. (For example, the IP address of the root router is 192.168.0.1, the IP address of the extended router can be 192.168.0.2 - 192.168.0.254. We take 192.168.0.2 as example.)

DHCP Server

IP Version: IPv4 IPv6

MAC Address: 0C-80-63-79-52-D3

IP Address: 192 . 168 . 0 . 2

Subnet Mask: 255.255.255.0

2) Click [Save](#) to make the settings effective.

Note: Log in to the web management page again if the IP address of the router is altered.

3. Select the wireless network to be bridged:

1) Go to [Advanced](#) > [Wireless](#) > [Advanced Settings](#) page. Locate the [WDS](#) section and select the [Enable WDS Bridging](#) check box to enable the WDS Bridging function.

WDS

2.4GHz | 5GHz

WDS Bridging: [Enable WDS Bridging](#)

SSID (to be bridged): [Scan](#)

MAC (to be bridged):

Security: [No Security](#) WPA/WPA2 Personal WEP

[Save](#)

2) Click [Scan](#) to detect all available AP devices and locate the network you want to bridge with.

AP List Refresh

ID	MAC Address	SSID	Signal Strength	Channel	Encryption	Connect
1	AC-84-C6-89-52-A0	MeetingRoom_2.4G	53	8	Encrypted	
2	34-8B-84-45-45-88	WiFi_Lan_2.4G_1000	53	5	Encrypted	
3	C8-71-5A-8F-42-43		49	5	Encrypted	
4	84-8E-75-4D-41-2C	WiFi_Lan_2.4G	48	1	Encrypted	
5	8C-8B-83-79-53-39	WiFi_Lan_2.4G	44	8	Encrypted	
6	52-85-82-4F-83-41	WiFi_Lan_2.4G	44	1	Encrypted	
7	84-84-22-81-23-88		43	5	Encrypted	
8	84-84-22-81-23-88	WiFi_Lan_2.4G	43	5	Encrypted	

1 2 3 4

Back

- 3) Click the [Connect](#) icon, and then the SSID and MAC will be automatically filled in, select the security options of the wireless network you selected and enter the password if it has one.

WDS 2.4GHz | 5GHz

WDS Bridging: Enable WDS Bridging

Name(SSID):

MAC (to be bridged):

Security: No Security WPA/WPA2 Personal WEP

Version: WPA-PSK WPA2-PSK

Encryption: TKIP AES

Password:

- 4) Click [Save](#) to make the settings effective.

4. Disable DHCP:

- 1) Go to [Advanced](#) > [Network](#) > [LAN Settings](#) page.
- 2) Clear the [Enable](#) check box of [DHCP](#) and click [Save](#).

Now, the root's wireless network is extended and you can use the router's SSID and password to enjoy the network.

Note:

1. The extended router can have different SSID and password from the root router, you can change your router's SSID and password on [Basic > Wireless](#) page.
2. You can also bridge a network manually: enter the SSID (network name) and MAC Address of the network to be bridged. Select a security type and enter related parameters, which should be the same as the network to be bridged.

Q5. What should I do if I cannot access the internet even though the configuration is finished?

1. Visit <http://tplinkwifi.net>, and log in with the password you set for the router.
2. Go to [Advanced > Status](#) to check internet status:

As the following image shows, if IP Address is a valid one, please try the methods below and try again:

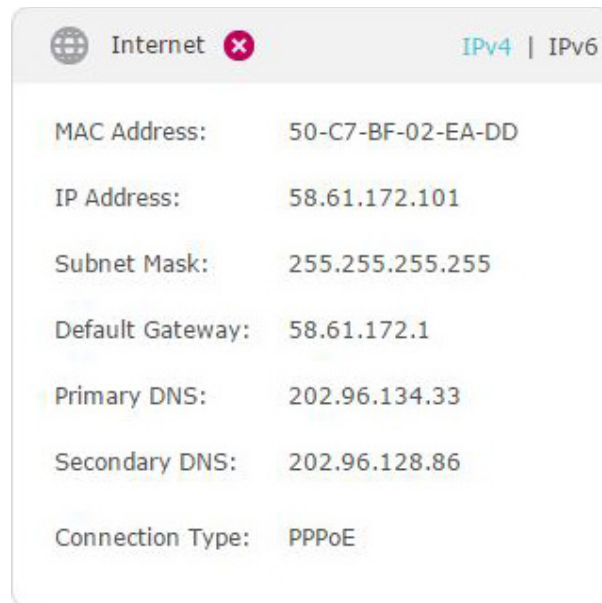

- Your computer might not recognize any DNS server addresses. Please manually configure the DNS server.

- 1) Go to [Advanced > Network > LAN Settings](#).
- 2) Enter 8.8.8.8 as Primary DNS, click [Save](#).

 **Tips:** 8.8.8.8 is a safe and public DNS server operated by Google.

DHCP: Enable

DHCP Server DHCP Relay

IP Address Pool: 192 . 168 . 0 . 100 - 192 . 168 . 0 . 199

Address Lease Time: 1440 minutes. (1-2880. The default value is 1440.)

Default Gateway: 192 . 168 . 0 . 1 (Optional)

Default Domain: (Optional)

Primary DNS: 8 . 8 . 8 . 8 (Optional)

Secondary DNS: 0 . 0 . 0 . 0 (Optional)

Save

- Restart the modem and the router.
 - 1) Power off your modem and router, and leave them off for 1 minute.
 - 2) Power on your modem first, and wait about 2 minutes until it gets a solid cable or Internet light.
 - 3) Power on the router.
 - 4) Wait another 1 or 2 minutes and check the internet access.
- Reset the router to factory default settings and reconfigure the router.
- Upgrade the firmware of the router.
- Check the TCP/IP settings on the particular device if all other devices can get internet from the router.

As the following image shows, if the IP Address is 0.0.0.0, please try the methods below and try again:

Internet ✖ IPv4 | IPv6

MAC Address: 50-C7-BF-02-EA-DD

IP Address: 0.0.0.0

Subnet Mask: 0.0.0.0

Default Gateway: 0.0.0.0

Primary DNS: 0.0.0.0

Secondary DNS: 0.0.0.0

Connection Type: PPPoE

- Make sure the physical connection between the router and the modem is proper.

- Clone the MAC address of your computer.
 - 1) Visit <http://tplinkwifi.net>, and log in with the password you set for the router.
 - 2) Go to **Advanced > Network > Internet** and click the edit icon to find the **MAC Clone** section.
 - 3) Choose an option as needed (enter the MAC address if **Use Custom MAC Address** is selected), and click **Save**.

Tips:

- Some ISP will register the MAC address of your computer when you access the internet for the first time through their Cable modem, if you add a router into your network to share your internet connection, the ISP will not accept it as the MAC address is changed, so we need to clone your computer's MAC address to the router.
- The MAC addresses of a computer in wired connection and wireless connection are different.

- Modify the LAN IP address of the router.

Note:

Most TP-Link routers use 192.168.0.1/192.168.1.1 as their default LAN IP address, which may conflict with the IP range of your existing ADSL modem/router. If so, the router is not able to communicate with your modem and you can't access the internet. To resolve this problem, we need to change the LAN IP address of the router to avoid such conflict, for example, 192.168.2.1.

- 1) Visit <http://tplinkwifi.net>, and log in with the password you set for the router.
- 2) Go to **Advanced > Network > LAN Settings**.
- 3) Modify the LAN IP address as the following image shows. Here we take 192.168.2.1 as an example.
- 4) Click **Save**.

- Restart the modem and the router.

- 1) Power off your modem and router, and leave them off for 1 minute.

- 2) Power on your modem first, and wait about 2 minutes until it get a solid cable or Internet light.
 - 3) Power on the router.
 - 4) Wait another 1 or 2 minutes and check the internet access.
- Double check the internet connection type.
 - 1) Confirm your internet connection type, which can be learned from the ISP.
 - 2) Visit <http://tplinkwifi.net>, and log in with the password you set for the router.
 - 3) Go to **Basic > Internet**.
 - 4) Select your **Internet Connection Type** and enter other parameters if required.
 - 5) Click **Save**.

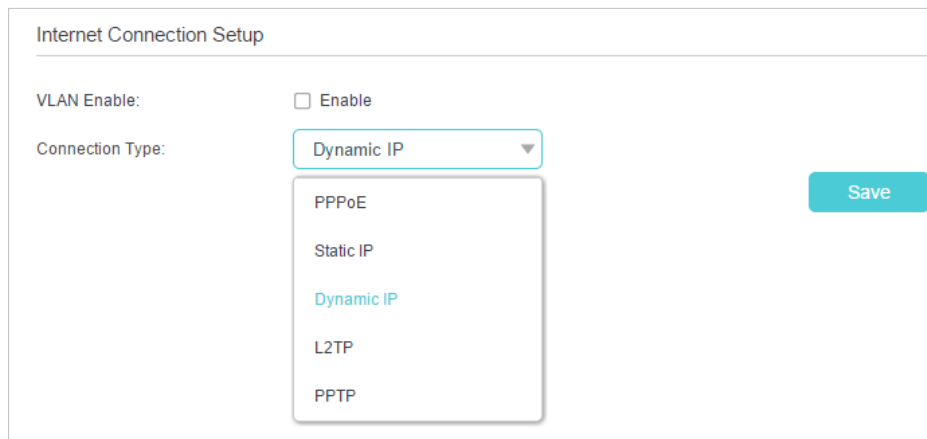

- 6) Restart the modem and the router again.
- Please upgrade the firmware of the router.

If you've tried every method above but still cannot access the internet, please contact the technical support.

Q6. What should I do if I cannot find my wireless network or I cannot connect the wireless network?

If you fail to find any wireless network, please follow the steps below:

- Make sure the wireless function of your device is enabled if you're using a laptop with built-in wireless adapter. You can refer to the relevant document or contact the laptop manufacturer.
- Make sure the wireless adapter driver is installed successfully and the wireless adapter is enabled.
 - **On Windows 7**
 - 1) If you see the message **No connections are available**, it is usually because the wireless function is disabled or blocked somehow.

- 2) Click [Troubleshoot](#) and windows might be able to fix the problem by itself.
- **On Windows XP**
 - 1) If you see the message [Windows cannot configure this wireless connection](#), this is usually because windows configuration utility is disabled or you are running another wireless configuration tool to connect the wireless.
 - 2) Exit the wireless configuration tool (the TP-Link Utility, for example).
 - 3) Select and right click on [My Computer](#) on desktop, select [Manage](#) to open Computer Management window.
 - 4) Expand [Services and Applications](#) > [Services](#), find and locate [Wireless Zero Configuration](#) in the Services list on the right side.
 - 5) Right click [Wireless Zero Configuration](#), and then select [Properties](#).
 - 6) Change [Startup type](#) to [Automatic](#), click on Start button and make sure the Service status is [Started](#). And then click [OK](#).

If you can find other wireless network except your own, please follow the steps below:

- Check the WLAN LED indicator on your wireless router/modem.
- Make sure your computer/device is still in the range of your router/modem. Move it closer if it is currently too far away.
- Go to [Advanced](#) > [Wireless](#) > [Wireless Settings](#), and check the wireless settings. Double check your Wireless Network Name and SSID is not hidden.

Wireless Settings 2.4GHz | 5GHz

Enable Wireless Radio

Network Name (SSID): Hide SSID

Security:

Version: Auto WPA2-PSK

Encryption: Auto TKIP AES

Password:

Mode:

Channel:

Channel Width:

Transmit Power: Low Middle High

[Save](#)

If you can find your wireless network but fail to connect, please follow the steps below:

- **Authenticating problem/password mismatch:**
 - 1) Sometimes you will be asked to type in a PIN number when you connect to the wireless network for the first time. This PIN number is different from the

Wireless Password/Network Security Key, usually you can only find it on the label of your router.



- 2) If you cannot find the PIN or PIN failed, you may choose [Connecting using a security key instead](#), and then type in the [Wireless Password/Network Security Key](#).
- 3) If it continues to show note of [Network Security Key Mismatch](#), it is suggested to confirm the wireless password of your wireless router.

Note: Wireless Password/Network Security Key is case sensitive.

- **Windows unable to connect to XXXX / Can not join this network / Taking longer than usual to connect to this network:**
 - Check the wireless signal strength of your network. If it is weak (1~3 bars), please move the router closer and try again.
 - Change the wireless Channel of the router to 1, 6 or 11 to reduce interference from other networks.
 - Re-install or update the driver for your wireless adapter of the computer.

COPYRIGHT & TRADEMARKS

Specifications are subject to change without notice.  tp-link is a registered trademark of TP-Link Technologies Co., Ltd. Other brands and product names are trademarks or registered trademarks of their respective holders.

No part of the specifications may be reproduced in any form or by any means or used to make any derivative such as translation, transformation, or adaptation without permission from TP-Link Technologies Co., Ltd. Copyright © 2019 TP-Link Technologies Co., Ltd. All rights reserved.

FCC STATEMENT



Product Name: AC1200 Wireless Dual Band Gigabit Router

Model Number: Archer C5

Component Name	Model
I.T.E POWER SUPPLY	AMS159A-1201000FU

Responsible party:

TP-Link USA Corporation, d/b/a TP-Link North America, Inc.

Address: 145 South State College Blvd. Suite 400, Brea, CA 92821

Website: <http://www.tp-link.com/us/>

Tel: +1 626 333 0234

Fax: +1 909 527 6803

E-mail: sales.usa@tp-link.com

This equipment has been tested and found to comply with the limits for a Class B digital device, pursuant to part 15 of the FCC Rules. These limits are designed to provide reasonable protection against harmful interference in a residential installation. This equipment generates, uses and can radiate radio frequency energy and, if not installed and used in accordance with the instructions, may cause harmful interference to radio communications. However, there is no guarantee that interference will not occur in a particular installation. If this equipment does cause harmful interference to radio or television reception, which can be determined by turning the equipment off and on, the user is encouraged to try to correct the interference by one or more of the following measures:

- Reorient or relocate the receiving antenna.
- Increase the separation between the equipment and receiver.
- Connect the equipment into an outlet on a circuit different from that to which the receiver is connected.
- Consult the dealer or an experienced radio/ TV technician for help.

This device complies with part 15 of the FCC Rules. Operation is subject to the following two conditions:

1. This device may not cause harmful interference.
2. This device must accept any interference received, including interference that may cause undesired operation.

Any changes or modifications not expressly approved by the party responsible for compliance could void the user's authority to operate the equipment.

Note: The manufacturer is not responsible for any radio or TV interference caused by unauthorized modifications to this equipment. Such modifications could void the user's authority to operate the equipment.

FCC RF Radiation Exposure Statement

This equipment complies with FCC RF radiation exposure limits set forth for an uncontrolled environment. This device and its antenna must not be co-located or operating in conjunction with any other antenna or transmitter.

"To comply with FCC RF exposure compliance requirements, this grant is applicable to only Mobile Configurations. The antennas used for this transmitter must be installed to provide a separation distance of at least 20 cm from all persons and must not be co-located or operating in conjunction with any other antenna or transmitter."

The device is restricted in indoor environment only.

We, **TP-Link USA Corporation**, has determined that the equipment shown as above has been shown to comply with the applicable technical standards, FCC part 15. There is no unauthorized change is made in the equipment and the equipment is properly maintained and operated.

Issue Date: 2019.03.20

FCC compliance information statement



Product Name: I.T.E POWER SUPPLY

Model Number: AMS159A-1201000FU

Responsible party:

TP-Link USA Corporation, d/b/a TP-Link North America, Inc.

Address: 145 South State College Blvd. Suite 400, Brea, CA 92821

Website: <http://www.tp-link.com/us/>

Tel: +1 626 333 0234

Fax: +1 909 527 6803

E-mail: sales.usa@tp-link.com

This equipment has been tested and found to comply with the limits for a Class B digital device, pursuant to part 15 of the FCC Rules. These limits are designed to provide reasonable protection against harmful interference in a residential installation. This equipment generates, uses and can radiate radio frequency energy and, if not installed and used in accordance with the instructions, may cause harmful interference to radio communications. However, there is no guarantee that interference will not occur in a particular installation. If this equipment does cause harmful interference to radio or

television reception, which can be determined by turning the equipment off and on, the user is encouraged to try to correct the interference by one or more of the following measures:

- Reorient or relocate the receiving antenna.
- Increase the separation between the equipment and receiver.
- Connect the equipment into an outlet on a circuit different from that to which the receiver is connected.
- Consult the dealer or an experienced radio/ TV technician for help.

This device complies with part 15 of the FCC Rules. Operation is subject to the following two conditions:

1. This device may not cause harmful interference.
2. This device must accept any interference received, including interference that may cause undesired operation.

Any changes or modifications not expressly approved by the party responsible for compliance could void the user's authority to operate the equipment.

We, **TP-Link USA Corporation**, has determined that the equipment shown as above has been shown to comply with the applicable technical standards, FCC part 15. There is no unauthorized change is made in the equipment and the equipment is properly maintained and operated.

Issue Date: 2019.03.20

CE Mark Warning



This is a class B product. In a domestic environment, this product may cause radio interference, in which case the user may be required to take adequate measures.

OPERATING FREQUENCY(the maximum transmitted power)

2400 MHz - 2483.5 MHz (20dBm)

5150 MHz - 5250 MHz (23dBm)

EU declaration of conformity

TP-Link hereby declares that the device is in compliance with the essential requirements and other relevant provisions of directives 2014/53/EU, 2009/125/EC and 2011/65/EU.

The original EU declaration of conformity may be found at <http://www.tp-link.com/en/ce>

RF Exposure Information

This device meets the EU requirements (2014/53/EU Article 3.1a) on the limitation of exposure of the general public to electromagnetic fields by way of health protection.

The device complies with RF specifications when the device used at 20 cm from your body.

Restricted to indoor use.

Canadian Compliance Statement

This device complies with Industry Canada license-exempt RSS standard(s). Operation is subject to the following two conditions:

1. This device may not cause interference, and
2. This device must accept any interference, including interference that may cause undesired operation of the device.

Le présent appareil est conforme aux CNR d'Industrie Canada applicables aux appareils radio exempts de licence. L'exploitation est autorisée aux deux conditions suivantes :

1. l'appareil ne doit pas produire de brouillage;
2. l'utilisateur de l'appareil doit accepter tout brouillage radioélectrique subi, même si le brouillage est susceptible d'en compromettre le fonctionnement

Caution:

1. The device for operation in the band 5150–5250 MHz is only for indoor use to reduce the potential for harmful interference to co-channel mobile satellite systems;

2. For devices with detachable antenna(s), the maximum antenna gain permitted for devices in the band 5725-5850 MHz shall be such that the equipment still complies with the e.i.r.p. limits specified for point-to-point and non-point-to-point operation as appropriate; and

The high-power radars are allocated as primary users (i.e. priority users) of the bands 5250-5350 MHz and 5650-5850 MHz and that these radars could cause interference and/or damage to LE-LAN devices.

Avertissement:

1. Le dispositif fonctionnant dans la bande 5150-5250 MHz est réservé uniquement pour une utilisation à l'intérieur afin de réduire les risques de brouillage préjudiciable aux systèmes de satellites mobiles utilisant les mêmes canaux;
2. Le gain maximal d'antenne permis pour les dispositifs avec antenne(s) amovible(s) utilisant la bande 5725-5850 MHz doit se conformer à la limitation P.I.R.E spécifiée pour l'exploitation point à point et non point à point, selon le cas.

En outre, les utilisateurs devraient aussi être avisés que les utilisateurs de radars de haute puissance sont désignés utilisateurs principaux (c.-à-d., qu'ils ont la priorité) pour les bandes 5250-5350 MHz et 5650-5850 MHz et que ces radars pourraient causer du brouillage et/ou des dommages aux dispositifs LAN-EL.

Radiation Exposure Statement:

This equipment complies with IC radiation exposure limits set forth for an uncontrolled environment. This equipment should be installed and operated with minimum distance 20 cm between the radiator & your body.

Déclaration d'exposition aux radiations:

Cet équipement est conforme aux limites d'exposition aux rayonnements IC établies pour un environnement non contrôlé. Cet équipement doit être installé et utilisé avec un minimum de 20 cm de distance entre la source de rayonnement et votre corps.

Industry Canada Statement

CAN ICES-3 (B)/NMB-3(B)

Korea Warning Statements:

당해 무선설비는 운용중 전파혼신 가능성이 있음.

NCC Notice:

注意！

依據 低功率電波輻射性電機管理辦法

第十二條 經型式認證合格之低功率射頻電機，非經許可，公司、商號或使用者均不得擅自變更頻率、加大功率或變更原設計之特性或功能。

第十四條 低功率射頻電機之使用不得影響飛航安全及干擾合法通行；經發現有干擾現象時，應立即停用，並改善至無干擾時方得繼續使用。前項合法通信，指依電信規定作業之無線電信。低功率射頻電機需忍受合法通信或工業、科學以及醫療用電波輻射性電機設備之干擾。

BSMI Notice

安全諮詢及注意事項

- 請使用原裝電源供應器或只能按照本產品注明的電源類型使用本產品。
- 清潔本產品之前請先拔掉電源線。請勿使用液體、噴霧清潔劑或濕布進行清潔。
- 注意防潮，請勿將水或其他液體潑灑到本產品上。
- 插槽與開口供通風使用，以確保本產品的操作可靠並防止過熱，請勿堵塞或覆蓋開口。
- 請勿將本產品置放於靠近熱源的地方。除非有正常的通風，否則不可放在密閉位置中。
- 請不要私自打開機殼，不要嘗試自行維修本產品，請由授權的專業人士進行此項工作。

限用物質含有情況標示聲明書

產品元件名稱	限用物質及其化學符號					
	鉛 Pb	鎘 Cd	汞 Hg	六價鉻 CrVI	多溴聯苯 PBB	多溴二苯醚 PBDE
PCB	○	○	○	○	○	○
外殼	○	○	○	○	○	○
電源適配器	-	○	○	○	○	○
備考1. 超出0.1 wt %” 及 “超出0.01 wt %” 系指限用物質之百分比含量超出百分比含量基準值。						
備考2. “○” 系指該項限用物質之百分比含量未超出百分比含量基準值。						
備考3. “ - ” 系指該項限用物質為排除項目。						



Продукт сертифіковано згідно с правилами системи УкрСЕПРО на відповідність вимогам нормативних документів та вимогам, що передбачені чинними законодавчими актами України.



Safety Information



- Keep the device away from water, fire, humidity or hot environments.
- Do not attempt to disassemble, repair, or modify the device.
- Do not use damaged charger or USB cable to charge the device.
- Do not use any other chargers than those recommended
- Do not use the device where wireless devices are not allowed.
- Adapter shall be installed near the equipment and shall be easily accessible.
-  Use only power supplies which are provided by manufacturer and in the original packing of this product. If you have any questions, please don't hesitate to contact us.

Please read and follow the above safety information when operating the device. We cannot guarantee that no accidents or damage will occur due to improper use of the device. Please use this product with care and operate at your own risk.

For EU/EFTA, this product can be used in the following countries:

AT	BE	BG	CH	CY	CZ	DE	DK
EE	EL	ES	FI	FR	HR	HU	IE
IS	IT	LI	LT	LU	LV	MT	NL
NO	PL	PT	RO	SE	SI	SK	UK

Explanations of the symbols on the product label

Symbol	Explanation
	DC voltage
	Indoor use only
	RECYCLING This product bears the selective sorting symbol for Waste electrical and electronic equipment (WEEE). This means that this product must be handled pursuant to European directive 2012/19/EU in order to be recycled or dismantled to minimize its impact on the environment. User has the choice to give his product to a competent recycling organization or to the retailer when he buys a new electrical or electronic equipment.